

DNER
LIGHTING & LED

LIGHTING SELECTED

CATALOG 2026

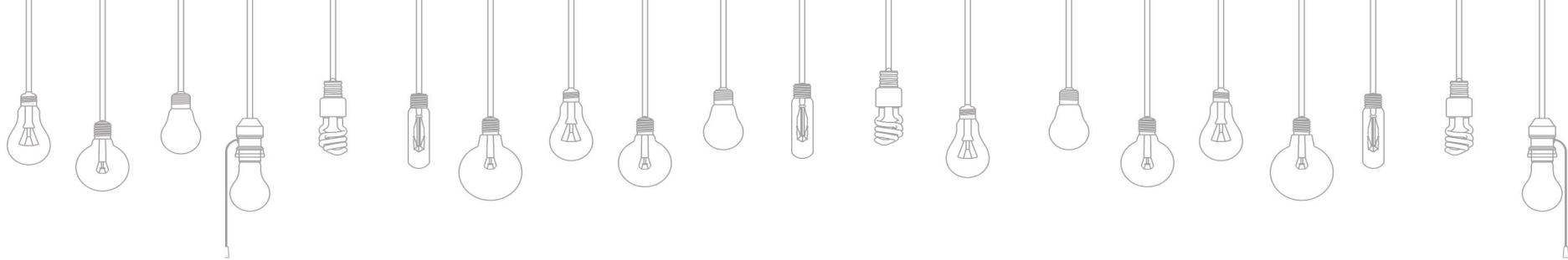

ABOUT DNER

DNER (ดีเนอร์) คือตราผลิตภัณฑ์ที่เกี่ยวกับ หลอดไฟ อุปกรณ์ให้แสงสว่าง และการบริการ ภายใต้แนวคิดใหม่ (Lighting Idea) ที่ช่วยให้การเลือกใช้ผลิตภัณฑ์และการออกแบบแสงสว่าง เป็นไปได้ง่ายขึ้น รวมถึงเป็นแนวทางให้กับลูกค้าในการเข้าใจการใช้งาน ความสวยงาม และความเหมาะสม ที่ตรงตามความต้องการที่แท้จริง สอดคล้องกับสไตล์การออกแบบในยุคปัจจุบันและตอบโจทย์ความต้องการในอนาคต

	Page
Downlight	3 - 33
Track light	34 - 50
LED Strip light & Ribbon & Neonflex	52 - 123
Decorative lamp & Lamp part	125 - 168
Light Bulb	169 - 203
Landscape lighting	204 - 231
LED Controller / LED Switching Power supply	232 - 249 ₂



RETROFIT & LED DOWNLIGHT

DNER RETROFIT DOWNLIGHT

DNER concept ... "QUICK & EASY"

Easy changing the light bulb.



Pull the inner part then replace the new DNER light bulb.

DNER LED MR16
12V & 220V



DNER LED GU10
220V



หลอดไฟ DNER มีมาตรฐานอุตสาหกรรม

มอก. 1955-2551
มอก. 2780-2562
K.S.T

More

DNER Downlight on page 5-31



Dia. 84mm.



DN4A001-WH / DN4A001/SL

Adjustable Downlight

Size : Dia.84 x H27mm.

Aluminum die-cast

Lamp : 1 x MR16 / [GU10](#)

Unit price : 100 / [130](#) THB



 Cutting
Dia.74mm.



Dia. 95mm.



DN4A053-BK DN4A053-WH

Adjustable Downlight

Size : Dia.95 x H31mm.

Aluminum die-cast

Lamp : 1 x MR16 / [GU10](#)

Unit price : 185 / [215](#) THB



 Cutting
Dia.80mm.



Dia. 110mm.



DN4A050

Fixed Downlight

Size : Dia.110 x H50mm.

Aluminum die-cast

Lamp : 1 x MR16 / [GU10](#)

Unit price : 175 / [205](#) THB



 Cutting
Dia.90mm.



Dia. 84mm.



902-BK / 902-WH

Adjustable Downlight

Size : Dia.84 x H27mm.

Aluminum die-cast

Lamp : 1 x MR16 / [GU10](#)

Unit price : 145 / [190 THB](#)



Cutting
Dia.74mm.



W 84mm.



906-BK / 906-WH

Adjustable Downlight

Size : L84 x W84 x H27mm.

Aluminum die-cast

Lamp : 1 x MR16 / [GU10](#)

Unit price : 160 / [200 THB](#)



Cutting
74 x 74mm.



DNGL85BK / DNGL85WH

Adjustable Downlight

Size : Dia.85 x H40mm.

Aluminum die-cast

Lamp : 1 x MR16 / [GU10](#)

Unit price : 290 / [320](#) THB



Cutting
Dia.75mm.



DNGL86BK / DNGL86WH

Adjustable Downlight

Size : W85 x L85 x H40mm.

Aluminum die-cast

Lamp : 1 x MR16 / [GU10](#)

Unit price : 290 / [320](#) THB

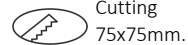

Cutting
75x75mm.



DNMRJ1685-WH
(MATT WHITE)

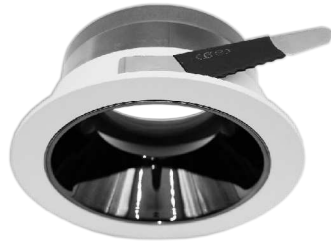

DNMRJ1685-BW
(DARK CHROME)



DNMRJ1685-BP
(BLACK and DARK CHROME)



ADJUSTABLE DOWNLIGHT

MATERIAL : ALUMINUM & PC

DIMENSION : Dia.86 x H45mm.

SOCKET TYPE : 1 x MR16 / **GU10** / **LED MODULE**

IP RATING : IP20

UNIT PRICE : 315 / 360 THB

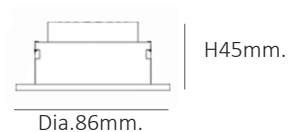
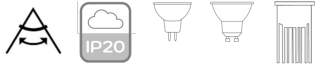



DN-GL1205WH / DN-GL1205BK

ADJUSTABLE DOWNLIGHT

MATERIAL : Aluminum white finished

DIMENSION : W105 x L205 x H45mm.

SOCKET TYPE : 2 x MR16 / [GU10](#)

IP RATING : IP20

UNIT PRICE : 860 / [920 THB](#)

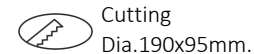
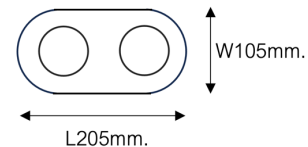

DN-GL1105WH / DN-GL1105BK

ADJUSTABLE DOWNLIGHT

MATERIAL : Aluminum white finished

DIMENSION : D105 x H45mm.

SOCKET TYPE : 1 x MR16 / [GU10](#)

IP RATING : IP20

UNIT PRICE : 430 / [475 THB](#)

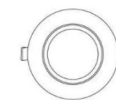

Dia. 105mm.





W 100mm.

AL-1601-BK / AL-1601-WH

Adjustable Downlight

Size : L100 x W100 x H40mm.

Aluminum die-cast

Lamp : 1 x MR16 / [GU10](#)

Unit price : 370 / [400](#) THB



 Cutting
85 x 85mm.



W 93mm.

DN4A051/BK / DN4A051/WH

Adjustable Downlight

Size : W93 x L93 x H35mm.

Aluminum die-cast

Lamp : 1 x MR16 / [GU10](#)

Unit price : 200 / [230](#) THB



 Cutting
Dia.80mm.



W 93mm..

DN4A054-BK / DN4A054-WBK

Adjustable Downlight

Size : W93 x L93 x H55mm.

Aluminum die-cast

Lamp : 1 x MR16 / [GU10](#)

Unit price : 230 / [260](#) THB



 Cutting
75 x 75mm.



GL135-1BK / GL135-1WH

Adjustable Downlight

Size : W92 x L92 x H26mm.

Aluminum die-cast

Lamp : 1 x MR16 / [GU10](#)

Unit price : 315 / [345](#) THB



W 92mm.



Cutting
Dia.80mm.



GL135-2BK / GL135-2WH

Adjustable Downlight

Size : W92 x L174 H26mm.

Aluminum die-cast

Lamp : 2 x MR16 / [GU10](#)

Unit price: 515 / [560](#) THB



L 174mm.



Cutting
160 x 80 mm.



W 100mm.



DNGL1085-BK / DNGL1085-WB / DNGL1085-WH

Adjustable Downlight

Size : L100 x W100 x H40mm.

Aluminum die-cast

Lamp : 1 x MR16 / [GU10](#)

Unit price : 360 / [390](#) THB



L 185mm.



DNGL1010-BK / DNGL1010-WB / DNGL1010-WH

Adjustable Downlight

Size : W100 x L185 X H35mm.

Aluminum die-cast

Lamp : 2 x MR16 / [GU10](#)

Unit price: 720 / [780](#) THB

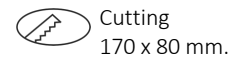



DN-GL101B-BK / DN-GL101B-WH

Adjustable Downlight

Size : W115 x L115 x H110mm.

Aluminum die-cast

Lamp : 1 x MR16 / [GU10](#)

Unit price : 430 / [460](#) THB



W 115mm.



Cutting
90 x 90mm.



DN-GL102B-BK / DN-GL102B-WH

Adjustable Downlight

Size : W115 x L215 x H110mm.

Aluminum die-cast

Lamp : 2 x MR16 / [GU10](#)

Unit price: 660 / [720](#) THB



L215mm.



Cutting
190 x 90mm.



G101S-BK / G101S-WH

Adjustable Downlight

Size : W85 x L85 x H54mm.

Aluminum die-cast

Lamp : 1 x MR16 / **GU10**

Unit price : 260 / **290** THB



W 85mm.



Cutting
75 x 75mm.



G102S-BK / G102S-WH

Adjustable Downlight

Size : W85 x L160 H40mm.

Aluminum die-cast

Lamp : 2 x MR16 / **GU10**

Unit price : 530 / **590** THB



L160mm.



Cutting
150 x 70 mm.



DN-DL6006

Fixed Downlight

Size : Dia.60 x H110mm.

Aluminum die-cast

Lamp : 1 x MR16 / [GU10](#)

Unit price : 645 / [675](#) THB

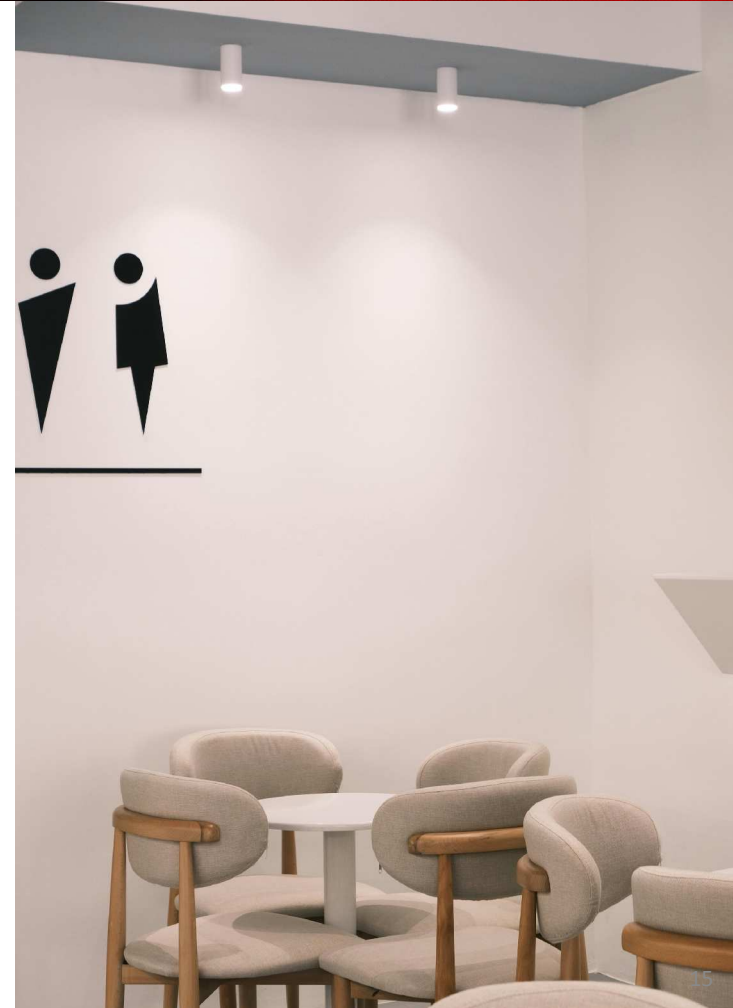
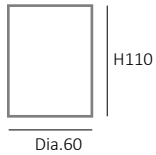



DNGR8084-BK / DNGR8084-WH

Adjustable Downlight

Size : W80 x L80 x H84mm.

Aluminum die-cast

Lamp : 1 x MR16 / [GU10](#)

Unit price : 460 / [490](#) THB



W 80mm.



DNGR8816-BK / DNGR8816-WH

Adjustable Downlight

Size : Dia.80 x H94mm.

Aluminum die-cast

Lamp : 1 x MR16 / [GU10](#)

Unit price : 460 / [490](#) THB



H94

Dia.80

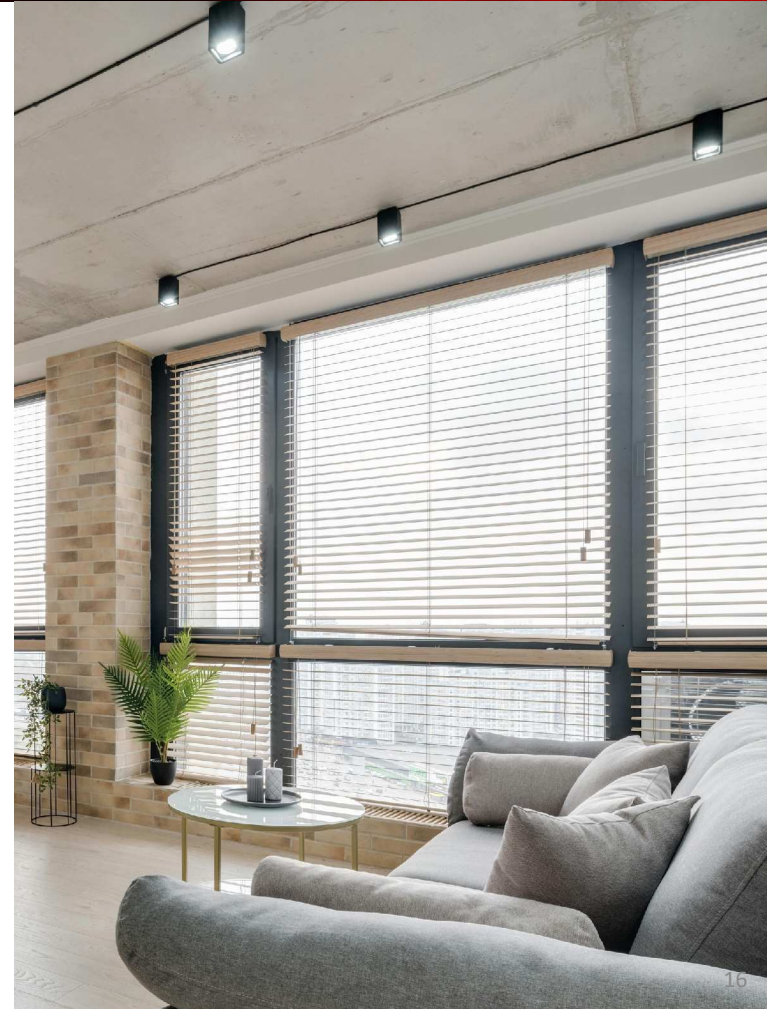



DN-MZ3001B-BK / DN-MZ3001B-GR / DN-MZ3001B-WH

OUTDOOR Fixed Downlight

Size : Dia.90 x H120mm.

Aluminum die-cast and glass

Lamp : 1 x GU10

Unit price : 690 THB

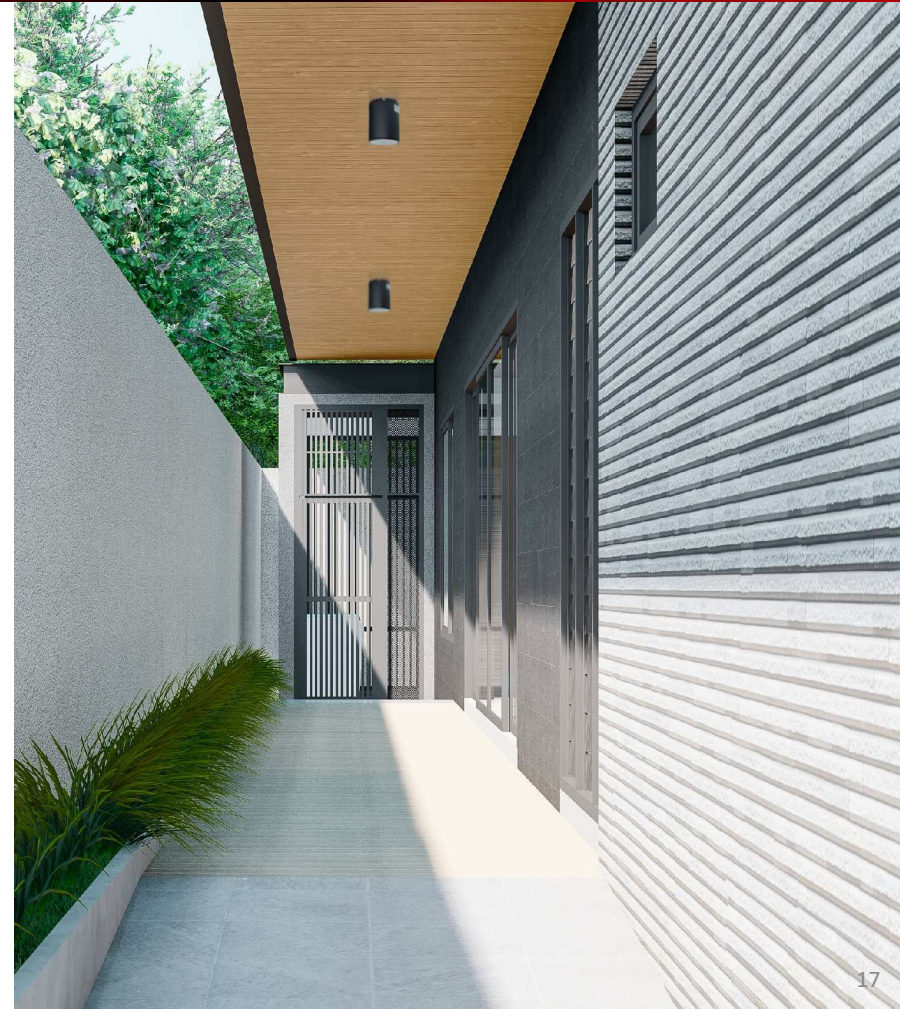
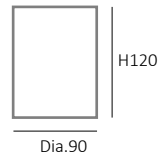



DN-GL2071-WH / DN-GL2071-BK

Adjustable Downlight

Size : W100 x L100 x H170mm.

Aluminum die-cast

Lamp : 1 x MR16 / [GU10](#)

Unit price : 660 / [690](#) THB

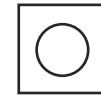

W 100mm.





DN-GL2072-WH / DN-GL2072-WB / DN-GL2072-BK

Adjustable Downlight

Size : W100 x L200 H170mm.

Aluminum die-cast

Lamp : 2 x MR16 / [GU10](#)

Unit price : 1150 / [1210](#) THB



L 200mm.





DN-GL108-WH / DN-GL108-WB / DN-GL108-BK

Adjustable Downlight

Size : W100 x L100 H100mm.

Aluminum die-cast

Lamp : 1 x GU10

Unit price : 850 THB

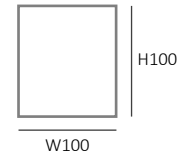



DN-GL208-WH / DN-GL208-WB / DN-GL208-BK

Adjustable Downlight

Size : W100 x L195 H100mm.

Aluminum die-cast

Lamp : 2 x GU10

Unit price : 1700 THB

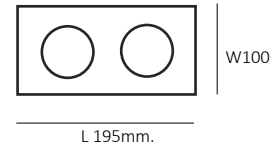



Minimal
Style



DN704 Slim-Trim

E27 Downlight

Size : Dia.138 x H145mm.

Aluminum die-cast white finished

Lamp : 1 x E27

Unit price : 430 THB



Cutting
Dia.128mm.





W 173mm.

DN-RP301-BK / DN-RP301-WH

Adjustable Downlight

Size : W173 x L173 x H155mm.

Aluminum die-cast

Lamp : 1 x E27

Unit price : 785 THB



Cutting
150 x 150mm.



L 330mm.

DN-RP302-BK / DN-RP302-WH

Adjustable Downlight

Size : W175 x L330 x H155mm.

Aluminum die-cast

Lamp : 2 x E27

Unit price : 1360 THB



Cutting
150 x 305mm.

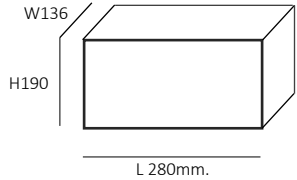

MD-4012S-BK / MD-4012S-WH

Fixed Downlight

Size : W136 x L280 x H190mm.

Aluminum die-cast

Lamp : 2 x E27

Unit price : 860 THB



DN-MZ3001C-BK / DN-MZ3001C-GR

Fixed Downlight

Size : Dia.108 x H200mm.

Aluminum die-cast and glass.

Lamp : 1 x E27

Unit price : 660 THB

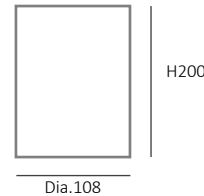



Square Surfaced Downlight

Fixed Downlight
Aluminum die-cast
Lamp : 1 x E27

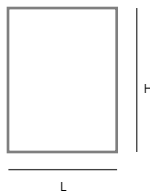

Round Surfaced Downlight

Fixed Downlight
Aluminum die-cast
Lamp : 1 x E27

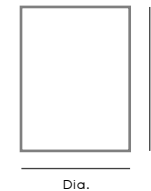

Code	Color	Dimensions	Unit price
MD-3016S-BK	Black	W110 x L110 x H155mm. (3")	275 THB
MD-3016S-WH	White	W110 x L110 x H155mm. (3")	275 THB
MD-4016S-BK	Black	W136 x L136 x H190mm. (4")	372 THB
MD-4016S-WH	White	W136 x L136 x H190mm. (4")	372 THB
MD-6016S-BK	Black	W170 x L170 x H205mm. (6")	565 THB
MD-6016S-WH	White	W170 x L170 x H205mm. (6")	565 THB
MD-8016S-BK	Black	W182 x L182 x H235mm. (8")	615 THB
MD-8016S-WH	White	W182 x L182 x H235mm. (8")	615 THB

Code	Color	Dimensions	Unit price
MD-3011C-BK	Black	Dia.110 x H115mm. (3")	186 THB
MD-3011C-WH	White	Dia.110 x H115mm. (3")	186 THB
MD-4011C-BK	Black	Dia.133 x H148mm. (4")	258 THB
MD-4011C-WH	White	Dia.133 x H148mm. (4")	258 THB
MD-6011C-BK	Black	Dia.170 x H180mm. (6")	415 THB
MD-6011C-WH	White	Dia.170 x H180mm. (6")	415 THB
MD-8011C-BK	Black	Dia.220 x H220mm. (8")	529 THB
MD-8011C-WH	White	Dia.220 x H220mm. (8")	529 THB

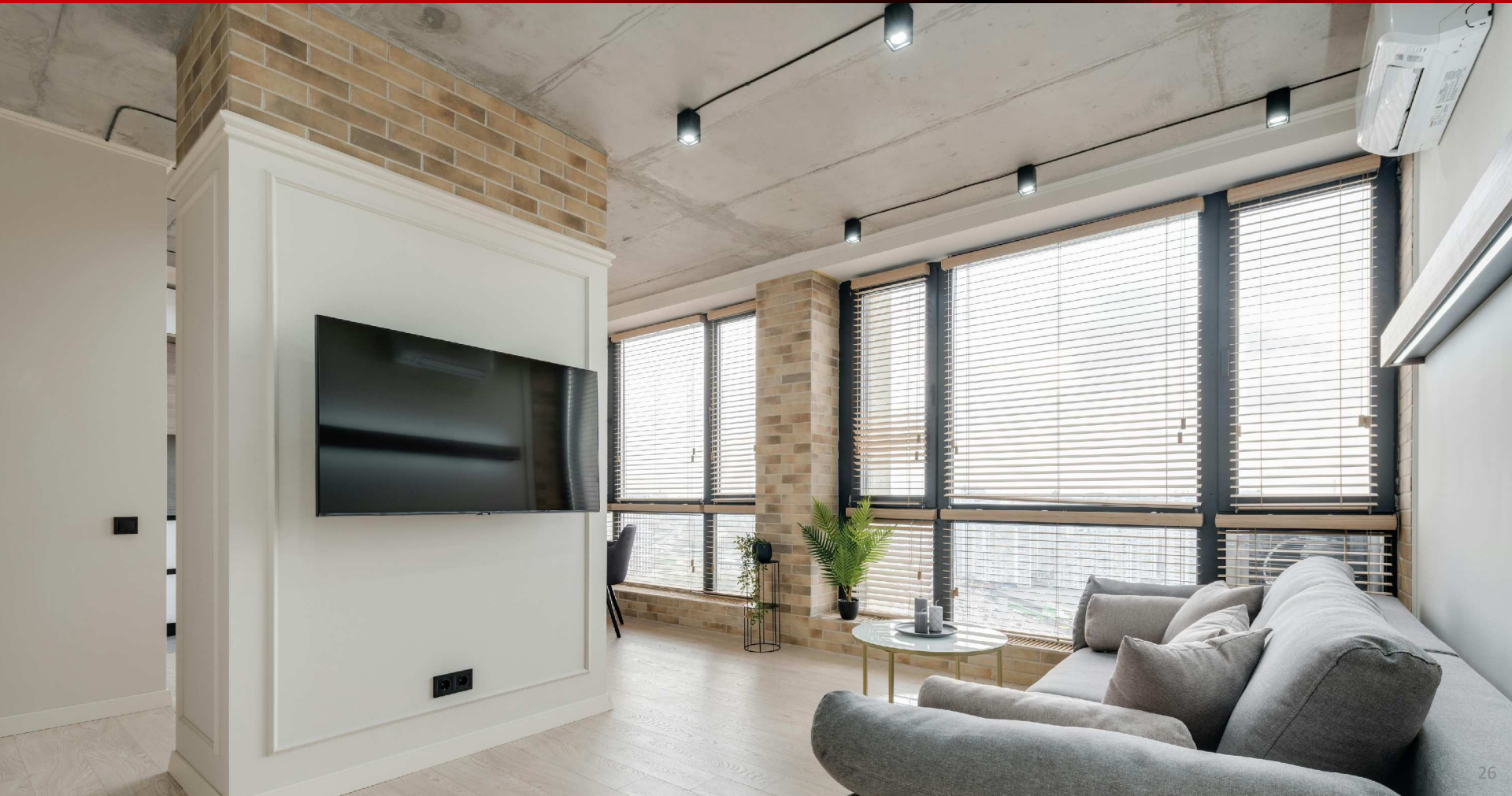

LED DOWNLIGHT



12w

SET LED DOWNLIGHT 12W

Voltage : **220V**

Watt : 12W

Lumens : 1200 lm

Beam angle : 38 degree

DIMENSION : Dia.86 x H100mm.

CRI : 90

Unit price : 890 THB

Light Color CODE :

DNMRJ1685+DNMJF012WW : Warmwhite

DNMRJ1685+DNMJF012NW : Natural 4000K

DNMRJ1685+DNMJF012WH : White Daylight



12w DIM

SET LED DOWNLIGHT 12W - DIMMABLE

Voltage : **220V**

Watt : 12W

Lumens : 1200 lm

Beam angle : 38 degree

DIMENSION : Dia.86 x H100mm.

CRI : 90

Unit price : 1,030 THB

Light Color CODE :

DNMRJ1685+DNMJF012WW-DIM : Warmwhite

DNMRJ1685+DNMJF012NW-DIM : Natural 4000K

DNMRJ1685+DNMJF012WH-DIM : White Daylight



DN-CWH03

Adjustable Downlight

Aluminum white finished

Power : **3W 220V**

Light : 3000K Warm white

6500K Daylight

Size : Dia.85 x H30mm.

Unit price : 215 THB



Dia. 85mm.



Cutting
Dia.75mm.



DN-CCW03

Adjustable Downlight

Aluminum silver finished

Power : **3W 220V**

Light : 3000K Warm white

6500K Daylight

Size : Dia.85 x H30mm.

Unit price : 215 THB



Dia. 85mm.



Cutting
Dia.75mm.

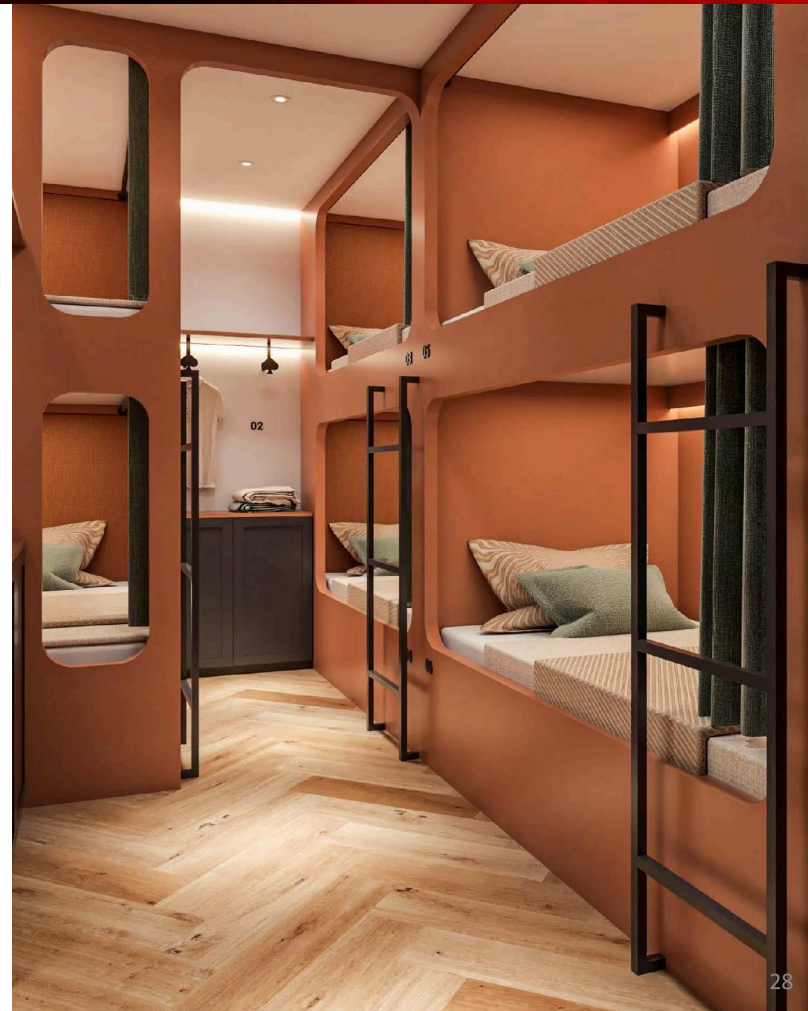

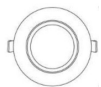

Dia. 85mm.

DNC05

LED Adjustable Downlight

Aluminum white finished

Power : **COB 5W 220V**

CODE : **DNC05WWW** - 3000K Warm white

DNC05W4K - 4000K Natural light

DNC05WWH - 6500K Daylight

Size : Dia.85 x H45mm.

Unit price : 200 THB



Cutting
Dia.70mm.

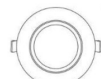

Dia. 85mm.

DNC05

LED Adjustable Downlight

Aluminum black finished

Power : **COB 5W 220V**

CODE : **DNC05BWW** - 3000K Warm white

DNC05B4K - 4000K Natural light

DNC05BWH - 6500K Daylight

Size : Dia.85 x H45mm.

Unit price : 200 THB



Cutting
Dia.70mm.

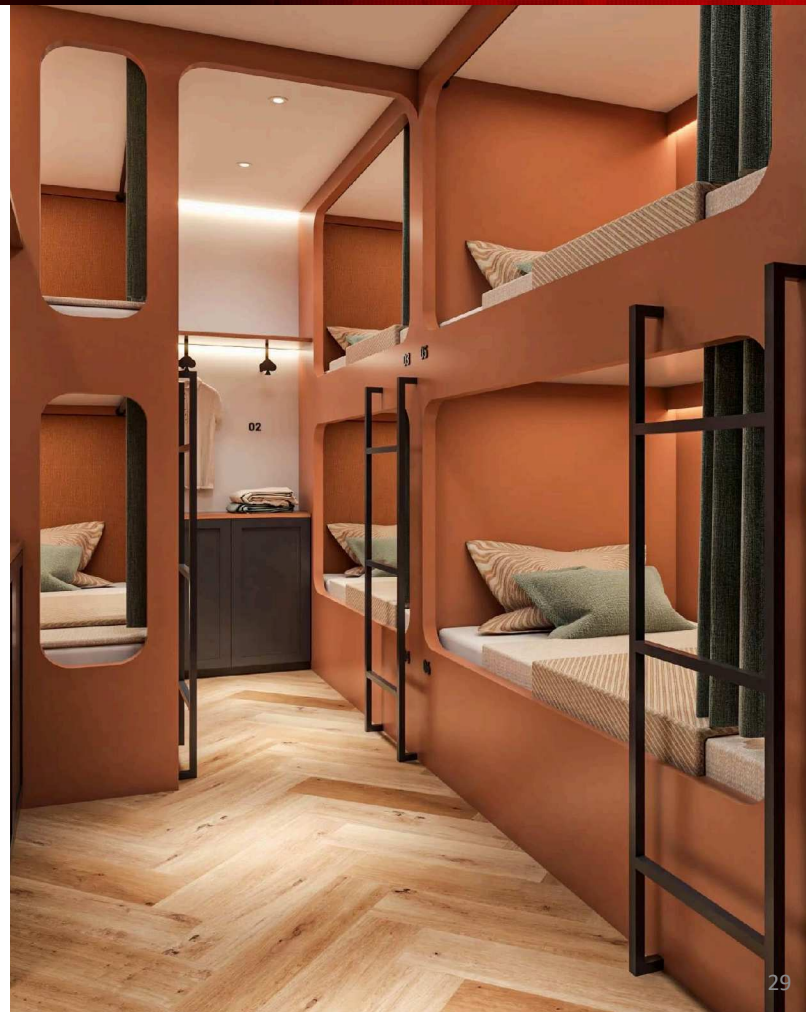



DN-CWH COB2" / DN-CBK COB2"

Adjustable Downlight

Aluminum white / Black finished

Power : **3W 220V**

Light : **3000K Warm white**

4000K Natural light

6500K Daylight

Size : Dia.52 x H17mm.

Unit price : 215 THB



Cutting
Dia.40mm.



Dia. 52mm.



DN-XC01

Fixed Downlight

Aluminum silver finished

Power : **2W 220V**

Light : **3000K Warm white**

6500K Daylight

Size : Dia.32 x H20mm.

Unit price : 290 THB



Dia. 32mm.



Cutting
Dia.25mm.



**3
W**



Dia. 52mm

Mini Downlight COB LENS 2"

DNDWHWW / DNDWHNL / DNDWHWH

Adjustable Downlight

Aluminum and PC

Power : **3W 220V**

Light : 3000K Warm white

4000K Natural light

6000K Daylight

Size : Dia.52 x H17mm.

Unit price : 230 THB



Cutting
Dia.40mm.



**3
W**



Dia. 52mm.

Mini Downlight COB LENS 2"

DNDBKWW / DNDBKNL / DNDBKWH

Adjustable Downlight

Aluminum and PC

Power : **3W 220V**

Light : 3000K Warm white

4000K Natural light

6000K Daylight

Size : Dia.52 x H17mm.

Unit price : 230 THB



Cutting
Dia.40mm.



**3
W**



Dia. 52mm.

Mini Downlight COB LENS 2"

DNDSLWW / DNDSLNL / DNDSLWH

Adjustable Downlight

Aluminum and PC

Power : **3W 220V**

Light : 3000K Warm white

4000K Natural light

6000K Daylight

Size : Dia.52 x H17mm.

Unit price : 230 THB



Cutting
Dia.40mm.



Round Recessed Downlight
Aluminum die-cast and diffuser
White trim
220V



Square Recessed Downlight
Aluminum die-cast and diffuser
White trim
220V



Code	Watts	Dimensions	Light	Price
DN-RSMD03	3w	Dia.82 x H15mm. គូរោង Dai.65mm.	Warm white 3000K	145 THB
			Natural light 4000K	
			Day light 6500K	
DN-RSMD09	9w	Dia.142 x H15mm. គូរោង Dia.132mm.	Warm white 3000K	175 THB
			Natural light 4000K	
			Day light 6500K	
DN-RSMD12	12w	Dia.165 x H15mm. គូរោង Dai.135mm.	Warm white 3000K	190 THB
			Natural light 4000K	
			Day light 6500K	
DN-RSMD18	18w	Dia.218 x H15mm. គូរោង Dia.200mm.	Warm white 3000K	290 THB
			Natural light 4000K	
			Day light 6500K	

Code	Watts	Dimensions	Light	Price
DN-SSMD09	9w	W145 x L145 x H15mm. គូរោង 132 x 132mm.	Warm white 3000K	190 THB
			Natural light 4000K	
			Day light 6500K	
DN-SSMD12	12w	W165 x L165 x H15mm. គូរោង 135 x 135mm.	Warm white 3000K	230 THB
			Natural light 4000K	
			Day light 6500K	
DN-SSMD18	18w	W220 x L220 x H15mm. គូរោង 200 x 200mm.	Warm white 3000K	330 THB
			Natural light 4000K	
			Day light 6500K	

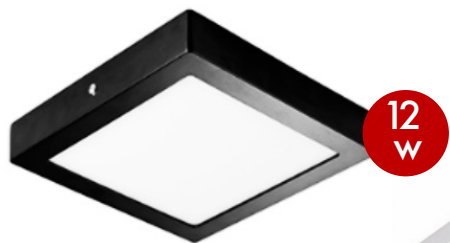

Square Suraced Downlight

DN-SSMD12M-BK

Aluminum die-cast and diffuser



Black trim

Dimension : W165 x L165 x H35mm.

Power : 12W

220V

Unit price : 430 THB

Warm white	3000K	
Natural light	4000K	
Day light	6500K	



Square Suraced Downlight

DN-SSMD12M

Aluminum die-cast and diffuser



White trim

Dimension : W165 x L165 x H35mm.

Power : 12W

220V

Unit price : 375 THB

Warm white	3000K	
Natural light	4000K	
Day light	6500K	



Round Suraced Downlight

DN-RSMD12M

Aluminum die-cast and diffuser



White trim

Dimension : Dia.155 x H28mm.

Power : 12W

220V

Unit price : 375 THB

Warm white	3000K	
Natural light	4000K	
Day light	6500K	



Round Suraced Downlight

DN-RSMD12M-BK

Aluminum die-cast and diffuser



Black trim

Dimension : Dia.155 x H28mm.

Power : 12W

220V

Unit price : 375 THB

Warm white	3000K	
Natural light	4000K	
Day light	6500K	



TRACK LIGHT & ACCESSORIES

MAGNETIC TRACK LIGHT



MAGNETIC TRACK LIGHT

รางไฟแทรกโลโก้ ระบบแม่เหล็ก ซ่อนฝังฝ้า

Recessed Magnetic Track

Aluminum Black finished

L : 1000mm. (1M.)

CODE : DN-HFL2521

Unit price : 580 THB

L : 2000mm. (2M.)

CODE : DN-HFL2522

Unit price : 1150 THB

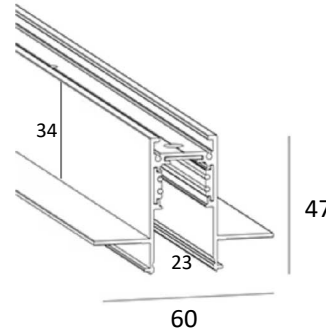

ZZ902W
*Corner connector
Unit price : 690 THB



ZT48V
*Straight connector
Unit price : 260 THB

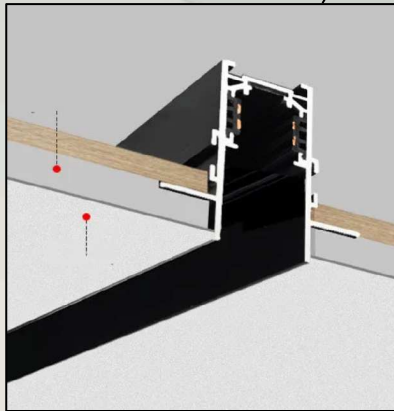

MAGNETIC TRACK LIGHT

Magnetic Linear Track Light System

คอมโพเนนต์ระบบแม่เหล็ก



Magnetic Track Light : Recessed type

18W

24 Degree

48V

Light Color :

DN20CXGS18WW : Warm White 3000K

DN20CXGS18NL : Natural Light 4000K

DN20CXGS18WH : White 6000K

Dimensions : W22 x H25 x L330mm.

Unit price : 580 THB



Magnetic Track Light : Recessed type

24W

48V

Light Color :

FG600-WW : Warm White 3000K

FG600-4K : Natural Light 4000K

Dimensions : W22 x H25x L600mm.

Unit price : 790 THB

MAGNETIC TRACK LIGHT



Magnetic Track Light

12W

24 Degree

48V

Light Color :

ZD12-WW : Warm White 3000K

ZD12-NL : Natural Light 4000K

Dimensions : W24 x L220 x H120mm.

Unit price : 930 THB



Magnetic Track Light

6W

24 Degree

48V

Light Color :

ZD6-WW : Warm White 3000K

ZD6-NL : Natural Light 4000K

Dimensions : W24 x L110 x H120mm.

Unit price : 690 THB

MAGNETIC TRACK LIGHT



Magnetic Track Light

20W

24 Degree

48V

Light Color :

GD20-B-WW : Warm White 3000K

GD20-B-4K : Natural Light 4000K

Dimensions : Dia.56 x L140mm.

Unit price : 830 THB



Power supply for magnetic track

PWC4810 – 100W

48V

100W

Unit price : 790 THB



PWC4820 – 200W

48V

200W

Unit price : 1150 THB

MAGNETIC TRACK LIGHT



รางไฟแทรคไลท์ ระบบแม่เหล็ก
รุ่นติดลอย / รุ่นโคมห้อย

DNDMFL2815 / **DNDMFL2816**

Surfaced / Hanging Magnetic Track

Aluminum Black finished

L : 1000mm. / **L : 2000mm.**

Unit price : 715 THB / **1430 THB**

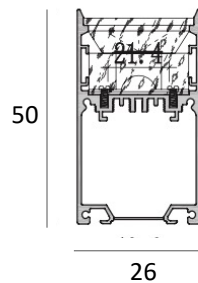

ZZ901M

Corner connector

Unit price : 695 THB

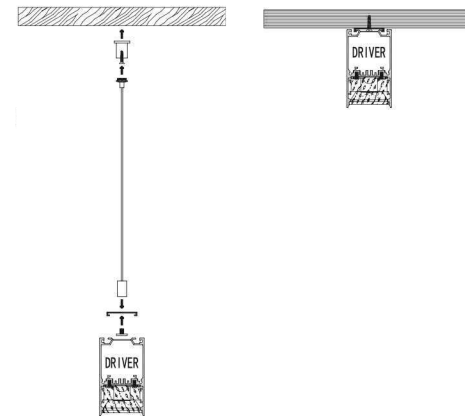



โคมไฟ Spot แบบติดราง



Track Light

DN-TR1106BK / DN-TR1106WH / DN-TR1106G

Aluminum die-cast

Black finished / White finished / Gold finished

Size : Dia.60 x L110 x H200mm.

Lamp : 1 x GU10

Unit price: 715 THB

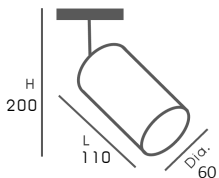

โคมไฟ Spot แบบมีแป้น



Surfaced Spot Light

DN-MU1106K / DN-MU1106WH / DN-MU1106G

Aluminum die-cast

Black finished / White finished / Gold finished

Size : Dia.60 x L110 x H200mm.

Lamp : 1 x GU10

Unit price : 645 THB

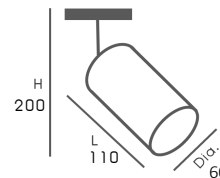



Track Light MR16
DN-TR10WH / DN-TR10BK
Aluminum die-cast
White finished / Black finished
Size : Dia.55 x L100 x H170mm.

Lamp : 1 x **MR16**
Unit price : 360 THB

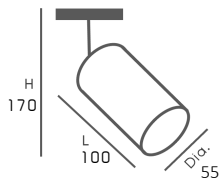

Surfaced Spot Light
DN-MR10WH / DN-MR10BK
Aluminum die-cast
White finished / Black finished
Size : Dia.55 x L100 x H170mm.

Lamp : 1 x **MR16**
Unit price : 390 THB



Track Light GU10
DN-GU1002WH / DN-GU1002BK
Aluminum die-cast
White finished / Black finished
Size : Dia.55 x L100 x H170mm.

Lamp : 1 x **GU10**
Unit price : 430 THB

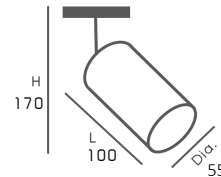

Surfaced Spot Light
DN-GU1003WH / DN-GU1003BK
Aluminum die-cast
White finished / Black finished
Size : Dia.55 x L100 x H170mm.

Lamp : 1 x **GU10**
Unit price : 460 THB



MR16 TRACK & SPOT LIGHT

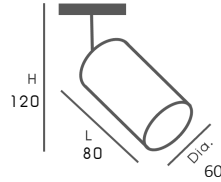

Surfaced Spot Light DN-TR05WH / DN-TR05BK

Aluminum die-cast
White finished / Black finished
Size : Dia.60 x L80 x H120mm.
Lamp : 1 x MR16
Unit price : 200 THB



Track Light
DN-TR04WH / DN-TR04BK
Aluminum die-cast
White finished / Black finished
Size : Dia.60 x L80 x H140mm.
Lamp : 1 x MR16
Unit price : 200 THB



Track Light
DN-TR08WH / DN-TR08BK
Aluminum die-cast
White finished / Black finished
Size : Dia.60 x L80 x H140mm.
Lamp : 1 x MR16
Unit price : 200 THB



Surfaced Spot Light DN-TR09WH / DN-TR09BK

Aluminum die-cast
White finished / Black finished
Size : Dia.60 x L80 x H120mm.
Lamp : 1 x MR16
Unit price : 200 THB



TRACK LIGHT & SPOT LIGHT



Track Light

DN-BWP02-WH

Aluminum die-cast

White finished

Size : Dia.115 x L150 x H255mm.

Lamp : 1 x E27 PAR30

Unit price : 375 THB



Track Light

DN-TR01WH / DN-TR01BB

Aluminum die-cast

White finished / Black finished

Size : Dia.113 x L142 x H240mm.

Lamp : 1 x E27 PAR30

Unit price : 175 THB



Track Light

DN-TR02WH / DN-TR02BB

Aluminum die-cast

White finished / Black finished

Size : Dia.115 x L142 x H195mm.

Lamp : 1 x E27 PAR30

Unit price : 175 THB



TRACK LIGHT & SPOT LIGHT



Track Light

DN-TR2701-WH / DN-TR2701-BK

Aluminum die-cast

White finished / Black finished

Size : Dia.50 x H170mm.

Lamp : 1 x E27

Unit price : 200 THB



Track Light

161AT-WH / 161AT-BK

Aluminum die-cast

White finished / Black finished

Size : Dia.100 x L160 x H245mm.

Lamp : 1 x E27 PAR30

Unit price : 190 THB



Track Light

DN-TR03WH / DN-TR03BK

Aluminum die-cast

White finished / Black finished

Size : Dia.98 x L148 x H230mm.

Lamp : 1 x E27 PAR30

Unit price : 195 THB



MR16 TRACK & SPOT LIGHT



LED Sur faced Spot Light

Aluminum die-cast

White finished / Black finished

Size : Dia.62 x L73 x H120mm.

Lamp : LED COB 9W

Unit price : 575 THB

DN-6A011-WH : Warm white 3000K

DN-6A012-WH : White Daylight 6500K

DN-6A013-BK : Warm white 3000K

DN-6A014-BK : White Daylight 6500K

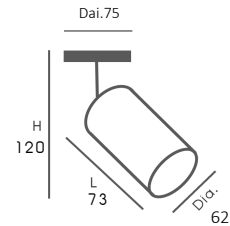

New
Item



Linea LED Track light

MODEL : DNTRF230 (Warm white)
DNTRF240 (Natural 4000K)

WATTS : 20W

DIMENSION : W34 x L330 x H50mm.

BEAM ANGLE : 120D

CRI : 90

IP RATING : IP20

VOLTAGE : 175-240V

Unit price : 580 THB



Linea LED Track light

MODEL : DNTJ330BK (Warm white)
DNTJ340BK (Natural light 4000K)

WATTS : 20W

LUMENS : 2800lm.

DIMENSION : W35 x L330 x H66mm.

BEAM ANGLE : 30D

IP RATING : IP20

VOLTAGE : 175-240V

Unit price : 580 THB

LED TRACK LIGHT

20
W

24Degree

LED Track Light 
DN-GL920 BK / DN-GL920 WH
Aluminum die-cast
Black finished / White finished
Size : Dia.64 x L158 x H215mm.
Lamp : 20W Warm white 3000K
Unit price : 500 THB



LED Track Light 
DN-GL920 BK / DN-GL920 WH
Aluminum die-cast
Black finished / White finished
Size : Dia.64 x L158 x H215mm.
Lamp : 20W Natural light 4000K
Unit price : 500 THB



LED Track Light 
DN-GL920 BK / DN-GL920 WH
Aluminum die-cast
Black finished / White finished
Size : Dia.64 x L158 x H215mm.
Lamp : 20W White 6500K
Unit price : 500 THB



24Degree

LED Track Light 
DN-GL930 BK / DN-GL930 WH
Aluminum die-cast
Black finished / White finished
Size : Dia.75 x L180 x H237mm.
Lamp : 30W Warm white 3000K
Unit price : 645 THB



LED Track Light 
DN-GL930 BK / DN-GL930 WH
Aluminum die-cast
Black finished / White finished
Size : Dia.75 x L180 x H237mm.
Lamp : 30W Natural light 4000K
Unit price : 645 THB



LED Track Light 
DN-GL930 BK / DN-GL930 WH
Aluminum die-cast
Black finished / White finished
Size : Dia.75 x L180 x H237mm.
Lamp : 30W White 6500K
Unit price : 645 THB





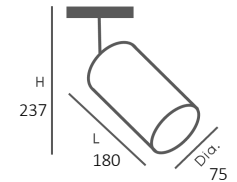
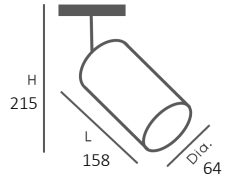



30
W





รางไฟแทรกไลท์อะลูมิเนียม 220V

รุ่นติดลอย

Code	Color	Lengths
TR-1M-WH-PR05		1 M. (1000mm.)
TR-1M-BK-PR05		Unit price : 195 THB
TR-1.5M-WH-PR05		1.5 M. (1500mm.)
TR-1.5M-BK-PR05		Unit price : 290 THB
TR-2M-WH-PR05		2 M. (2000mm.)
TR-2M-BK-PR05		Unit price : 375 THB



End Cap

PRO5HWBK  / PRO5HWWH 
Unit price : 86 THB



I-Type Connector

PRO5180BK  / PRO5180WH 
Unit price : 86 THB



Corner Connector

PRO590BK  / PRO590WH 
Unit price : 100 THB



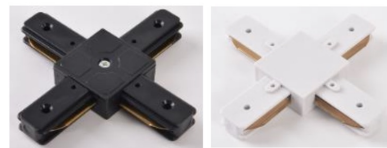

T-Type Connector

PRO5T3BK  / PRO5T3WH 
Unit price : 145 THB



X-Type Connector

PRO5T4BK  / PRO5T4WH 
Unit price : 186 THB



DISPLAY LIGHTING



KSH-H30

Unit price : 2 pcs. 160 THB



KSH-H20

Unit price : 2 pcs. 143 THB



KSH-H10

Unit price : 2 pcs. 130 THB



KSH-H6

Unit price : 2 pcs. 115 THB



GU5.3 Socket

LED STRIPLIGHT & ALUMINUM PROFILE

LED STRIPLIGHT COB

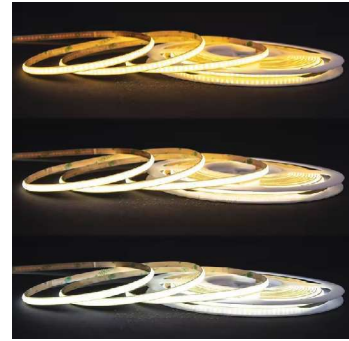

Micro LED COB Strip Light

Chips 400leds
Beam angle 120 Degree
CRI 90
Unit Roll 10m.
Price 1100 THB / Roll

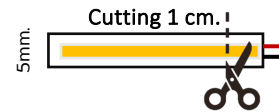

Model	Voltage	Watt	CCT	Lumen	PCB. Size	IP Rating
DN8A087WW	24VDC	8W/m.	Warm white	800lm./w	5mm.	20
DN8A087NL	24VDC	8W/m.	Cool Natural light	800lm./w	5mm.	20
DN8A087WH	24VDC	8W/m.	White Daylight	800lm./w	5mm.	20

LED STRIPLIGHT COB

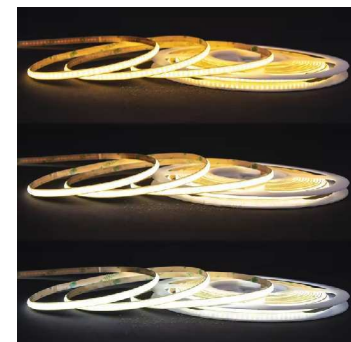

Free Cutting LED COB Strip Light

Chips	528leds
Beam angle	120 Degree
CRI	90
Unit Roll	5m.
Price	1260 THB / Roll



Model	Voltage	Watt	CCT	Lumen	PCB. Size	IP Rating
MHCOB1212WW	12VDC	13W/m.	Warm white	1300lm./m.	8mm.	20
MHCOB1212NW	12VDC	13W/m.	Cool Natural light	1300lm./m.	8mm.	20
MHCOB1212WH	12VDC	13W/m.	White Daylight	1300lm./m.	8mm.	20
MHCOB2412WW	24VDC	13W/m.	Warm white	1300lm./m.	8mm.	20
MHCOB2412NW	24VDC	13W/m.	Cool Natural light	1300lm./m.	8mm.	20
MHCOB2412WH	24VDC	13W/m.	White Daylight	1300lm./m.	8mm.	20

LED STRIPLIGHT COB

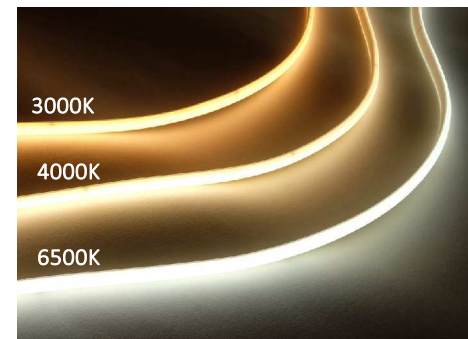
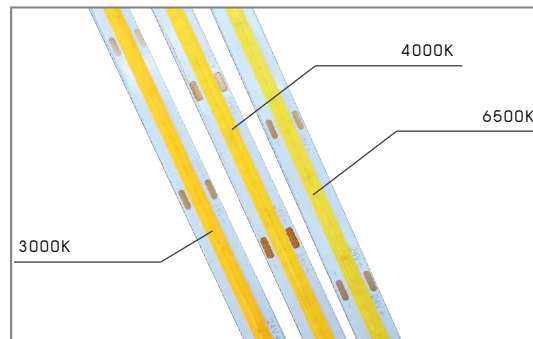

IP20 LED COB Strip Light

Chips	312leds
Beam angle	120 Degree
CRI	90
Unit Roll	5m.
Price	925 THB / Roll

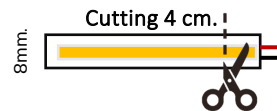

Model	Voltage	Watt	CCT	Lumen	PCB. Size	IP Rating
DN8A079	24VDC	11W/m.	Warm white	770lm./m.	8mm.	20
DN8A080	24VDC	11W/m.	Cool Natural light	770lm./m.	8mm.	20
DN8A081	24VDC	11W/m.	White Daylight	770lm./m.	8mm.	20
DN8A082	12VDC	11W/m.	Warm white	770lm./m.	8mm.	20
DN8A083	12VDC	11W/m.	Cool Natural light	770lm./m.	8mm.	20
DN8A084	12VDC	11W/m.	White Daylight	770lm./m.	8mm.	20

LED STRIPLIGHT COB

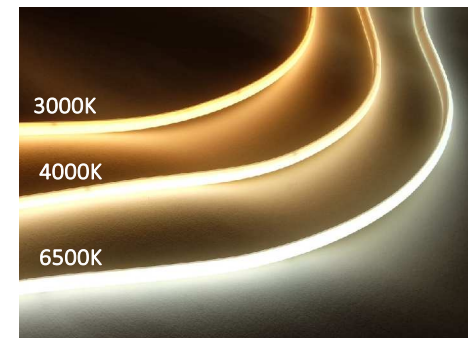

3000K

4000K

6500K

IP65 LED COB Strip Light

Chips 312leds
Beam angle 120 Degree
CRI 90
Unit Roll 5m.
Price 930 THB / Roll

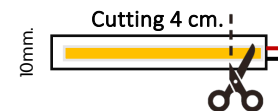

11w

24V
DC

12V
DC



Model	Voltage	Watt	CCT	Lumen	PCB. Size	IP Rating
DN8A089WW	24VDC	11W/m.	Warm white	770lm./m.	8mm.	65
DN8A089NL	24VDC	11W/m.	Cool Natural light	770lm./m.	8mm.	65
DN8A089WH	24VDC	11W/m.	White Daylight	770lm./m.	8mm.	65
DN8A088WW	12VDC	11W/m.	Warm white	770lm./m.	8mm.	65
DN8A088NL	12VDC	11W/m.	Cool Natural light	770lm./m.	8mm.	65
DN8A088WH	12VDC	11W/m.	White Daylight	770lm./m.	8mm.	65

LED STRIPLIGHT COB

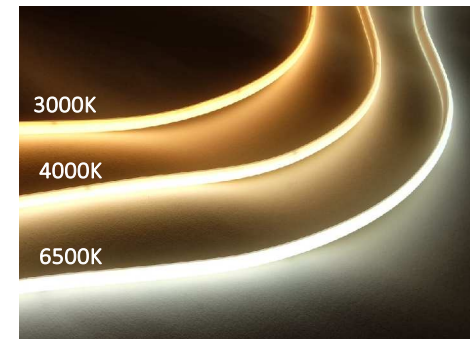

IP68 LED COB Strip Light

Chips 312leds
Beam angle 120 Degree
CRI 90
Unit Roll 5m.
Price 1220 THB / Roll

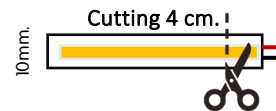

11w

24V
DC

12V
DC



Model	Voltage	Watt	CCT	Lumen	PCB. Size	IP Rating
COB2468PWW	24VDC	11W/m.	Warm white	770lm./m.	8mm.	68
COB2468P4K	24VDC	11W/m.	Cool Natural light	770lm./m.	8mm.	68
COB2468PWH	24VDC	11W/m.	White Daylight	770lm./m.	8mm.	68
COB1268PWW	12VDC	11W/m.	Warm white	770lm./m.	8mm.	68
COB1268P4K	12VDC	11W/m.	Cool Natural light	770lm./m.	8mm.	68
COB1268PWH	12VDC	11W/m.	White Daylight	770lm./m.	8mm.	68

LED STRIPLIGHT

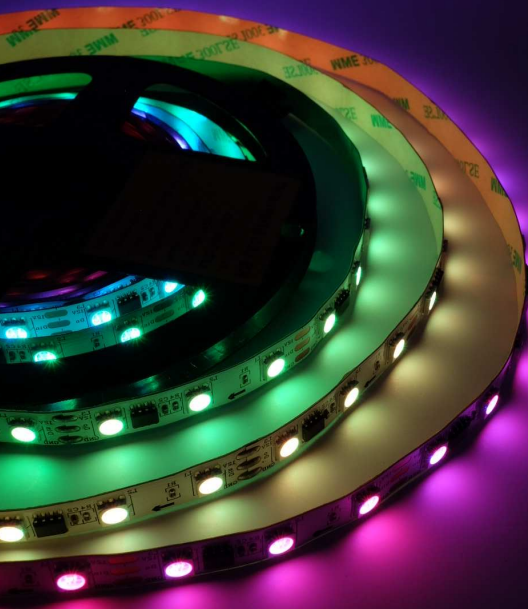

Magic RGB Full color

2811 3P

LED CHIP : 5050 / 60leds
VOLTAGE : 12V
WATTS : 14.4W/m.
DIMENSION : PCB W:10mm.
LUMENS : 1050lm./m.
BEAM ANGLE : 120D
IP RATING : IP20
Unit price : 930 THB

12V
DC

14.4W



5m.
roll

CODE

DN28113WNK	RGB	
------------	-----	--

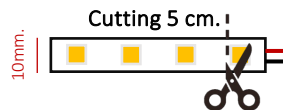

Magic RGB Full color

2811 3P

LED CHIP : 5050 / 60leds
VOLTAGE : 12V
WATTS : 14.4W/m.
DIMENSION : PCB W:10mm.
LUMENS : 1050lm./m.
BEAM ANGLE : 120D
IP RATING : IP65
Unit price : 1000 THB

12V
DC

14.4W



5m.
roll

CODE

DN8A042	RGB	
---------	-----	--

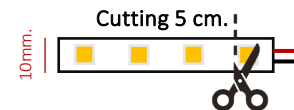

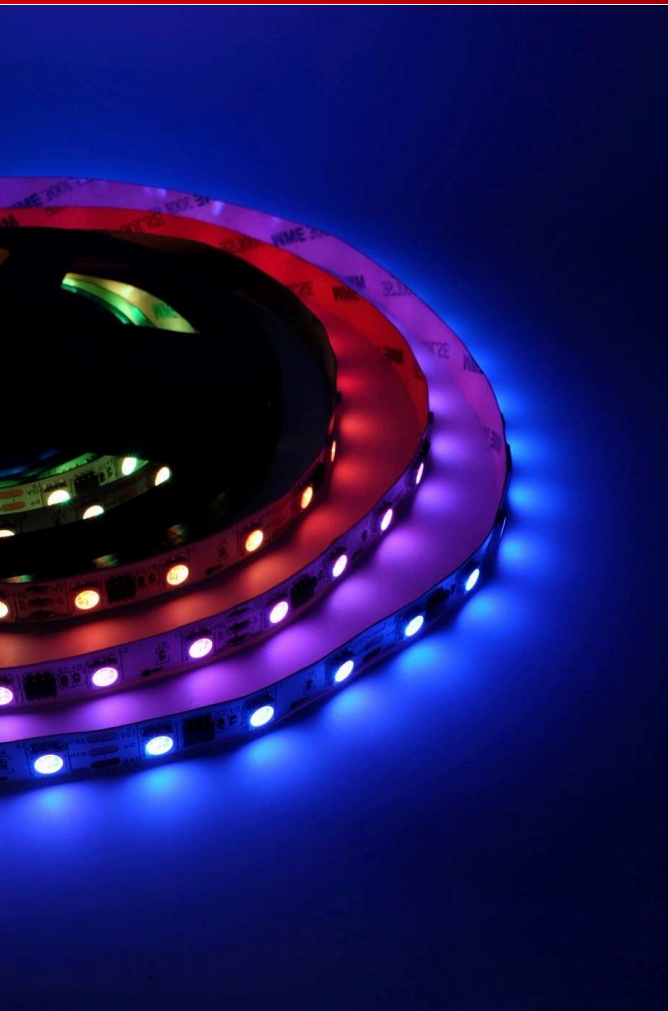

Magic RGB

Full color

WS2818 Double data 4P

LED CHIP : 5050 / 60leds

VOLTAGE : 12V

WATTS : 14.4W/m.

DIMENSION : PCB W:10mm.

LUMENS : 1050lm./m.

BEAM ANGLE : 120D

IP RATING : IP20

Unit price : 2625 THB

12V
DC

14.4W

IP20

5m.
roll

CODE

DN8A043

RGB

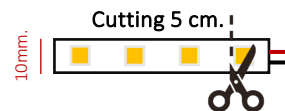

LED STRIPLIGHT



Magic RGB Full color 16703IC Double data 4P

LED CHIP : 5050 / 60leds
VOLTAGE : 12V
WATTS : 14.4W/m.
DIMENSION : PCB W:10mm.
LUMENS : 1050lm./m.
BEAM ANGLE : 120D
IP RATING : IP20
Unit price : 1575 THB

12V
DC

14.4W



5m.
roll

CODE

DN167033WNK	RGB	
-------------	-----	--

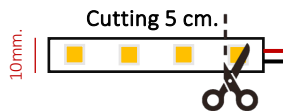

Magic RGB Full color 16703IC Double data 4P

LED CHIP : 5050 / 60leds
VOLTAGE : 12V
WATTS : 14.4W/m.
DIMENSION : PCB W:12mm.
LUMENS : 1050lm./m.
BEAM ANGLE : 120D
IP RATING : IP65
Unit price : 1790 THB

12V
DC

14.4W



5m.
roll

CODE

DN167033WTG	RGB	
-------------	-----	--

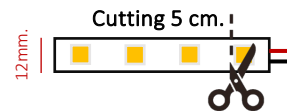



Magic RGB Full color 16703 3P

LED CHIP : 5050 / 60leds
 VOLTAGE : 12V
 WATTS : 14.4W/m.
 DIMENSION : PCB W:10mm.
 LUMENS : 1050lm./m.
 BEAM ANGLE : 120D
 IP RATING : IP20
 Unit price : 930 THB

12V
DC

14.4W

IP20

5m.
roll

CODE

RGB		
-----	--	--

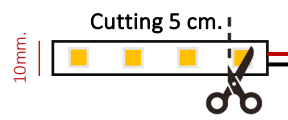

Magic RGB Full color 16703 3P

LED CHIP : 5050 / 60leds
 VOLTAGE : 12V
 WATTS : 14.4W/m.
 DIMENSION : PCB W:12mm.
 LUMENS : 1050lm./m.
 BEAM ANGLE : 120D
 IP RATING : IP65
 Unit price : 1000 THB

12V
DC

14.4W

IP65

5m.
roll

CODE

DN167033WTG	RGB	
-------------	-----	--

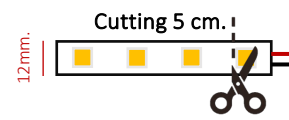



RGB

LED Strip light RGB 5050
LED CHIP : 5050 / 60leds
VOLTAGE : 12V
WATTS : 14.4W/m.
DIMENSION : PCB W:10mm.
LUMENS : 1500lm./m.
BEAM ANGLE : 120D
IP RATING : IP20
Unit price : 490 THB /Roll

12V
DC

14.4W

IP20

5m.
roll

CODE

DN8A027	RGB	
---------	-----	--

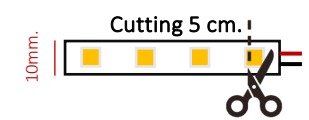

RGB

LED Strip light RGB 5050
LED CHIP : 5050 / 60leds
VOLTAGE : 12V
WATTS : 14.4W/m.
DIMENSION : PCB W:12mm.
LUMENS : 1050lm./m.
BEAM ANGLE : 120D
IP RATING : IP65
Unit price : 600 THB / roll

12V
DC

14.4W

IP65

5m.
roll

CODE

DN8A035	RGB	
---------	-----	--

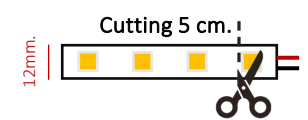

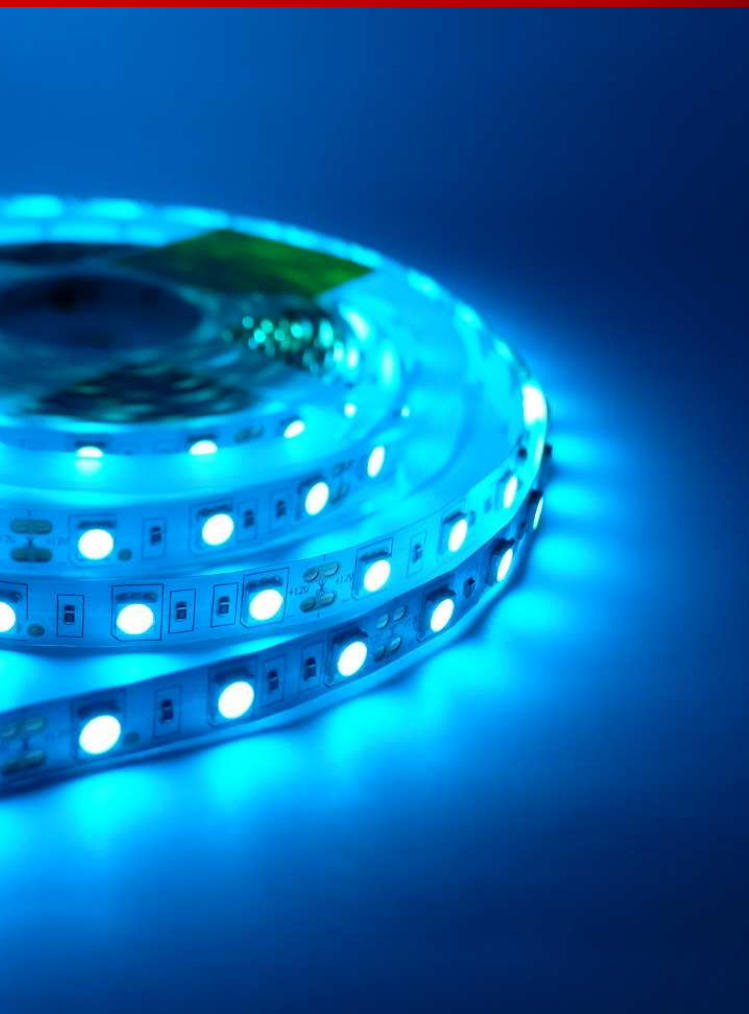

ICE BLUE

LED Strip light 5050

LED CHIP : 5050 / 60leds

VOLTAGE : 12V

WATTS : 14.4W/m.

DIMENSION : PCB W:10mm.

LUMENS : 1500lm./m.

BEAM ANGLE : 120D

IP RATING : IP20

Unit price : 515 THB / roll

12V
DC

14.4W

IP20

5m.
roll

CODE

DN8A030	Ice blue	
---------	----------	---





SUPER WHITE 12000K

LED Strip light 5050
 LED CHIP : 5050 / 60leds
 VOLTAGE : 12V
 WATTS : 14.4W/m.
 DIMENSION : PCB W:10mm.
 LUMENS : 1500lm./m.
 BEAM ANGLE : 120D
 IP RATING : IP20
 Unit price : 500 THB / roll

12V
DC

14.4W

IP20

5m.
roll

CODE

DN8A024	12000K	<input type="checkbox"/>
---------	--------	--------------------------





12V
DC

14.4W



IP20

5m.
roll

LED CHIP : 5050 / 60leds
VOLTAGE : 12V
WATTS : 14.4W/m.
DIMENSION : PCB W:10mm.
LUMENS : 1500lm./m.
BEAM ANGLE : 120D
IP RATING : IP20

CODE

Unit price

DN8A028	Warm white		345 THB / roll
DN8A022	Natural light		515 THB / roll
DN8A023	Day light		345 THB / roll

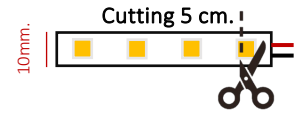

12V
DC

14.4W



IP65

5m.
roll

LED CHIP : 5050 / 60leds
VOLTAGE : 12V
WATTS : 14.4W/m.
DIMENSION : PCB W:10mm.
LUMENS : 1500lm./m.
BEAM ANGLE : 120D
IP RATING : IP65

CODE

Unit price

DN8A031	Warm white		545 THB / roll
DN8A032	Natural light		545 THB / roll
DN8A033	Day light		545 THB / roll





Micro
5mm.

12V
DC



14.4W

IP20

5m.
roll

LED CHIP : 2835 / 120leds
 VOLTAGE : 12V
 WATTS : 14.4W/m.
 DIMENSION : PCB W:5mm.
 LUMENS : 1500lm./m.
 BEAM ANGLE : 120D
 IP RATING : IP20
 Unit price : 515 THB / roll

CODE

DN8A001	Warm white	
DN8A002	Natural light	
DN8A003	Day light	

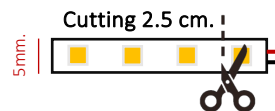

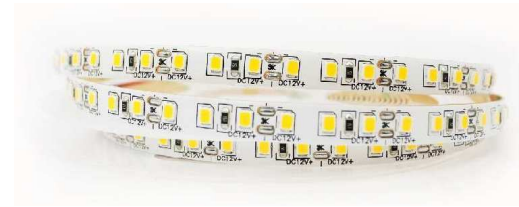

LED CHIP : 2835 / 120leds
VOLTAGE : 12V
WATTS : 9.6W/m.
DIMENSION : PCB W:8mm.
LUMENS : 1150lm./m.
BEAM ANGLE : 120D
IP RATING : IP20
 Unit price : 545 THB / roll

12V
DC

9.6W

IP20

5m.
roll

CODE

DN8A004	Warm white	
DN8A005	Natural light	
DN8A006	Day light	



LED CHIP : 2835 / 120leds
VOLTAGE : 12V
WATTS : 9.6W/m.
DIMENSION : PCB W:10mm.
LUMENS : 1150lm./m.
BEAM ANGLE : 120D
IP RATING : IP65
 Unit price : 690 THB / roll

12V
DC

9.6W

IP65

5m.
roll

CODE

DN8A007	Warm white	
DN8A008	Natural light	
DN8A009	Day light	

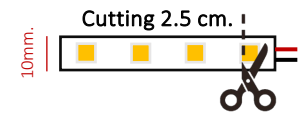



LED CHIP : 2835 / 60leds
 VOLTAGE : 12V
 WATTS : 4.8W/m. / 7.2W/m.
 DIMENSION : PCB W:8mm.
 LUMENS : 570lm./m.
 BEAM ANGLE : 120D
 IP RATING : IP20
 Unit price : 400 THB / roll

12V DC
4.8W
 IP20
 5m. roll

CODE

DN8A016	4.8W - Warm white	<input checked="" type="checkbox"/>
DN8A016-1	7.2W - Warm white	<input checked="" type="checkbox"/>

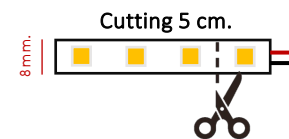

LED CHIP : 2835 / 240leds
 VOLTAGE : 12V
 WATTS : 28.8W/m.
 DIMENSION : PCB W:10mm.
 LUMENS : 10000lm./m.
 BEAM ANGLE : 120D
 IP RATING : IP20
 Unit price : 1260 THB / roll

12V DC
28.8W
 IP20
 5m. roll

CODE

DN8A017	Warm white	<input checked="" type="checkbox"/>
DN8A018	Natural light	<input type="checkbox"/>
DN8A019	Day light	<input type="checkbox"/>

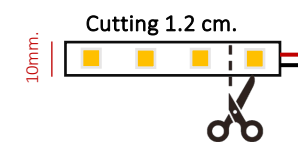



RGB Controller
DN8A055



RGB Controller
DN8A055

LED CHIP : 5050 RGB + 2835 WH/WW
VOLTAGE : 12V
WATTS : 14.4W/m.
DIMENSION : PCB W:12mm.
LUMENS : 1050lm./m.
BEAM ANGLE : 120D
IP RATING : IP20
Unit price : 1290 THB / roll



CODE

DN8A037	RGB+WH+WW			
---------	-----------	--	--	--

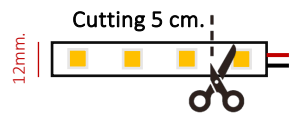

LED CHIP : 5050 RGB + 2835 WH/WW
VOLTAGE : 12V
WATTS : 14.4W/m.
DIMENSION : PCB W:12mm.
LUMENS : 1050lm./m.
BEAM ANGLE : 120D
IP RATING : IP65
Unit price : 1400 THB / roll



CODE

DN8A038	RGB+WH+WW			
---------	-----------	--	--	--

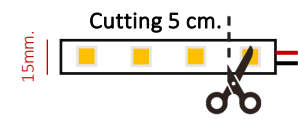



**10m.
Roll**

LED CHIP : 2835 / 120leds

VOLTAGE : 24V

WATTS : 9.6W/m.

DIMENSION : PCB W:10mm.

LUMENS : 1000lm./m.

BEAM ANGLE : 120D

IP RATING : IP20

ROLL : 10m.



Unit price : 860 THB / roll

24V
DC

9.6W

IP20

CODE

Warm white	DN8A010M10	
Natural light	DN8A011M10	
Day light	DN8A012M10	

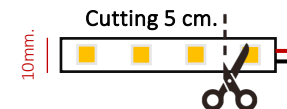



**100m.
Roll**

**24V
DC**

14.4W

IP65

LED CHIP : 2835 / 120leds
VOLTAGE : 24V
WATTS : 14.4 W/m.
DIMENSION : PCB W:10mm.
LUMENS : 1000lm./m.
BEAM ANGLE : 120D
IP RATING : IP67
ROLL : 100m.
Unit price : 6,000 THB / roll

CODE

Warm white	DN8A085WW	
Natural light	DN8A085NW	
Day light	DN8A085WH	

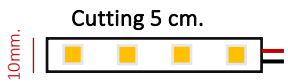



DOUBLE LINE

**100m.
Roll**

**24V
DC**

28.8W

IP65

LED CHIP : 2835 / 120leds
VOLTAGE : 24V
WATTS : 28.8 W/m.
DIMENSION : PCB W:12mm.
LUMENS : 2000lm./m.
BEAM ANGLE : 120D
IP RATING : IP67
ROLL : 100m.
Unit price : 10,720 THB / roll

CODE

Warm white	DN8A086WW	
Natural light	DN8A086NW	
Day light	DN8A086WH	



Cutting 5 cm.





220
Vac

100m.
Roll



TE120D

LED CHIP : 2835 / 120leds
VOLTAGE : 220V
WATTS : 8 W/m.
DIMENSION : PCB W:8mm.
LUMENS : 1000lm./m.
BEAM ANGLE : 120D
IP RATING : IP65
ROLL : 100m.
Unit price : 5,200 THB / roll

CODE

Warm white	TE120DWW	
Natural light	TE120DNW	
Day light	TE120DWH	



Cutting 10 cm.



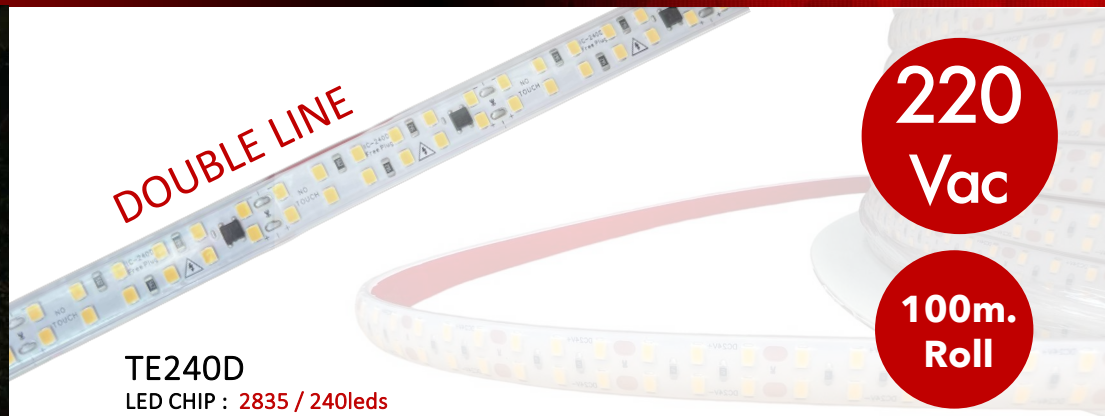

220
Vac

100m.
Roll



TE240D

LED CHIP : 2835 / 240leds

VOLTAGE : 220V

WATTS : 16 W/m.

DIMENSION : PCB W:11mm.

LUMENS : 2000lm./m.



BEAM ANGLE : 120D

IP RATING : IP65

ROLL : 100m.

Unit price : 8,000 THB / roll

CODE

Warm white	TE240DWW	
Natural light	TE240DNW	
Day light	TE240DWH	

Cutting 5 cm.





LED CHIP : 5050 / 60leds

VOLTAGE : 24V

WATTS : 14.4W/m.

DIMENSION : PCB W:10mm.

LUMENS : 1500lm./m.

BEAM ANGLE : 120D

IP RATING : IP20

Unit price : 430 THB / roll



24V
DC

14.4W

IP20

5m.
roll

CODE

DN8A039	Warm white	
DN8A040	Natural light	
DN8A041	Day light	

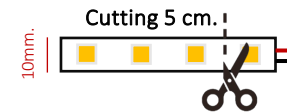



LED CHIP : 2835 / 60leds
 VOLTAGE : 24V
 WATTS : 4.8W/m.
 DIMENSION : PCB W:8mm.
 LUMENS : 570lm./m.
 BEAM ANGLE : 120D
 IP RATING : IP20
 Unit price : 400 THB / roll

24V DC
4.8W
 IP20
5m. roll

CODE

DN8A077	Warm white	
DN8A078	Natural light	

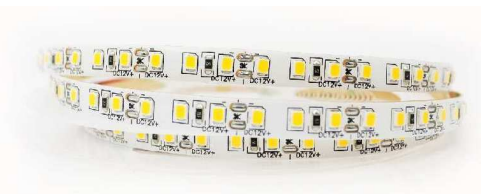
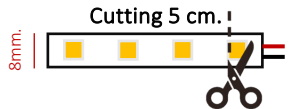

LED CHIP : 2835 / 120leds
 VOLTAGE : 24V
 WATTS : 9.6W/m.
 DIMENSION : PCB W:8mm.
 LUMENS : 1050lm./m.
 BEAM ANGLE : 120D
 IP RATING : IP20
 Unit price : 545 THB / roll

24V DC
9.6W
 IP20
5m. roll

CODE

DN8A010	Warm white	
DN8A011	Natural light	
DN8A012	Day light	

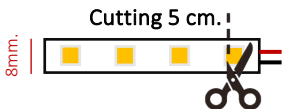

LED CHIP : 2835 / 120leds
 VOLTAGE : 24V
 WATTS : 9.6W/m.
 DIMENSION : PCB W:10mm.
 LUMENS : 1050lm./m.
 BEAM ANGLE : 120D
 IP RATING : IP65
 Unit price : 690 THB / roll

24V DC
9.6W
 IP65
5m. roll

CODE

DN8A013	Warm white	
DN8A014	Natural light	
DN8A015	Day light	

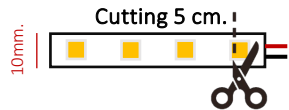



RA2P10-1 : ตัวต่อสายแดงดำ รุ่น 5050

Unit price : 30 THB



MA2P8-1 : ตัวต่อสายแดงดำ รุ่น 2835 / COB

Unit price : 30 THB



OB2P8 : ตัวต่อตรง 180 องศา

Unit price : 30 THB



O2P90L : ตัวต่อมุม 90 องศา COB

Unit price : 50 THB



CBP8L : ตัวต่อตรง 90 องศา SMD

Unit price : 43 THB



COB6802 : ตัวต่อตรง 180 องศา

ห่อละ 5 ตัว

Unit price : 215 THB

COB6803 : ตัวต่อมุม 90 องศา

ห่อละ 5 ตัว

Unit price : 315 THB

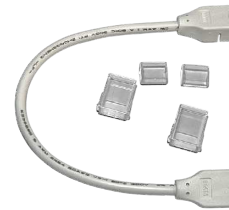

COB6801 : ปลั๊กต่อ / สายต่อกลาง

Unit price : 143 THB

YB2P8

ตัวต่อกลาง LED Striplight แบบต่อตรง

Unit price : 10 THB

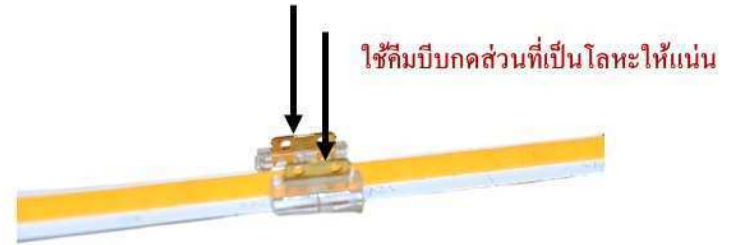

S02P-8-L

ตัวต่อกลาง LED Striplight แบบเข้ามุมฉาก

Unit price : 25 THB



YA2P81

ตัวต่อสาย LED Striplight แบบสายแดงดำ

Unit price : 12 THB





สายแดง-ดำ ต่อกกลาง 2 ด้าน

SPSC2H

Unit price : 36 THB



สายแดง-ดำ หัวแจ๊คดำ 2 ด้าน

SP2W2G

Unit price : 43 THB



สาย RGB 4 เส้น หัวแจ๊คดำ

SP28114P

Unit price : 65 THB



สายต่อ RGB 4 เส้น 2 ด้าน

SPRGB2H

Unit price : 65 THB



สายต่อ RGB 4 เส้น ด้านเดียว

SPRGB1H

Unit price : 50 THB

Micro Size!

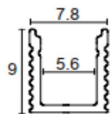

XQ129 1M / XQ129 2M

L : 1000mm. / 2000mm.

PCB : 5.5mm.

Unit price : 145 THB / 290 THB



Accessories set included

For all model.

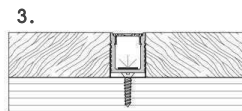
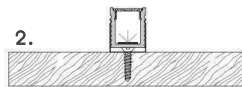
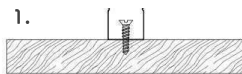

Installation steps



Mini size Surface-mounted linear fixture

These Surface-mounted linear fixtures are our hot-selling products with a narrow, low profile. The 118-degree beam angle is ideal for a wide, even spread of light like in cove and wall-washing applications. They can create clean, modern linear designs for retail stores, commercial buildings and residential interiors. Some of them can also be used in conjunction with our tiltable stands. There are includes a choice of clear, frosted or milky diffuser. We also support customized product if you have a good idea.

046



ALUMINUM PROFILE SET

For LED Strip light

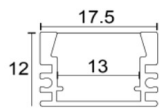

HC006 1M / HC006 2M
L : 1000mm. / 2000mm.
PCB : 10mm.
Unit price : 190 THB / 375 THB

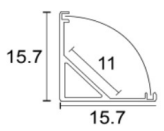

HC008 1M / HC008 2M
L : 1000mm. / 2000mm.
PCB : 10mm.
Unit price : 160 THB / 315 THB

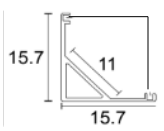

HC008 1M / HC008 2M (เหลี่ยม)
L : 1000mm. / 2000mm.
PCB : 10mm.
Unit price : 160 THB / 315 THB

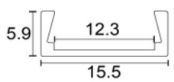

HC012 1M / HC012 2M
L : 1000mm. / 2000mm.
PCB : 10mm.
Unit price : 145 THB / 290 THB



*Corner connector
For HC013

ALUMINUM PROFILE SET

For LED Strip light

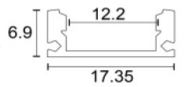

HC013 1M / HC013 2M

L : 1000mm. / 2000mm.

PCB : 10mm.

Unit price : 160 THB / 315 THB

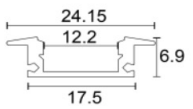

HC014 1M / HC014 2M

L : 1000mm. / 2000mm.

PCB : 10mm.

Unit price : 165 THB / 330 THB

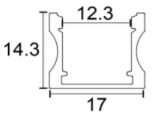

HC048 1M / HC048 2M

L : 1000mm. / 2000mm.

PCB : 10mm.

Unit price : 200 THB / 400 THB

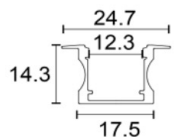

HC074 1M / HC074 2M

L : 1000mm. / 2000mm.

PCB : 10mm.

Unit price : 260 THB / 515 THB

*Corner connector
For HC013



*Corner connector
For HC048



ALUMINUM PROFILE SET

For LED Strip light

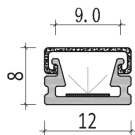

HC066 1M / HC066 2M

L : 1000mm. / 2000mm.

PCB : 10mm.

Unit price : 145 THB / 290 THB

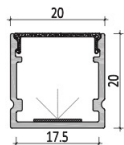

XQ-168-M2020 1M / XQ-168-M2020 2M

L : 1000mm. / 2000mm.

PCB : 10mm.

Unit price : 230 THB / 460 THB

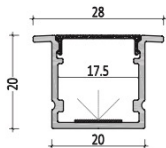

XQ-177-Y2820 1M / XQ-177-Y2820 2M

L : 1000mm. / 2000mm.

PCB : 10mm.

Unit price : 290 THB / 575 THB

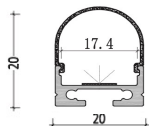

XQ-070-M2020 1M / XQ-070-M2020 2M

ฝ้าโค้ง

L : 1000mm. / 2000mm.

PCB : 10mm.

Unit price : 180 THB / 360 THB

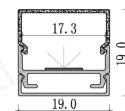
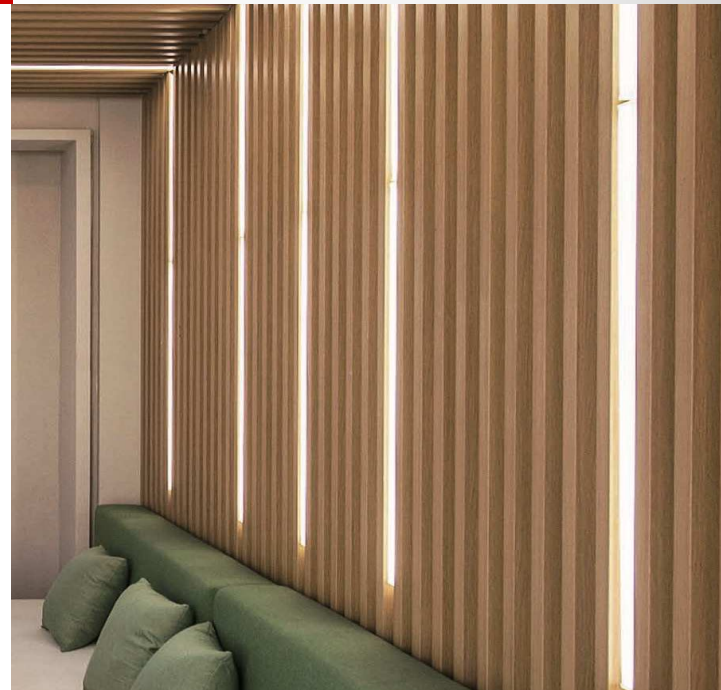

XQ-070-M2020 1M / XQ-070-M2020 2M

ฝ้าเหลี่ยม

L : 1000mm. / 2000mm.

PCB : 17.3mm.

Unit price : 180 THB / 360 THB

ALUMINUM PROFILE SET

For LED Strip light

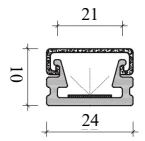

XQ-071-M2410 1M / XQ-071-M2410 2M

L : 1000mm. / 2000mm.

PCB : 12mm.

Unit price : 200 THB / 400 THB

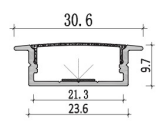

XQ-044-Y3110 1M / XQ-044-Y3110 2M

L : 1000mm. / 2000mm.

PCB : 12mm.

Unit price : 245 THB / 490 THB

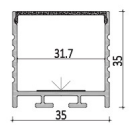

XQ-111-M3535 1M / XQ-111-M3535 2M

L : 1000mm. / 2000mm.

PCB : 12mm.

Unit price : 660 THB / 1315 THB

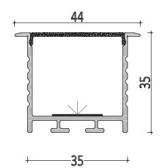

XQ-109-Y4435 1M / XQ-109-Y4435 2M

L : 1000mm. / 2000mm.

PCB : 12mm.

Unit price : 690 THB / 1375 THB

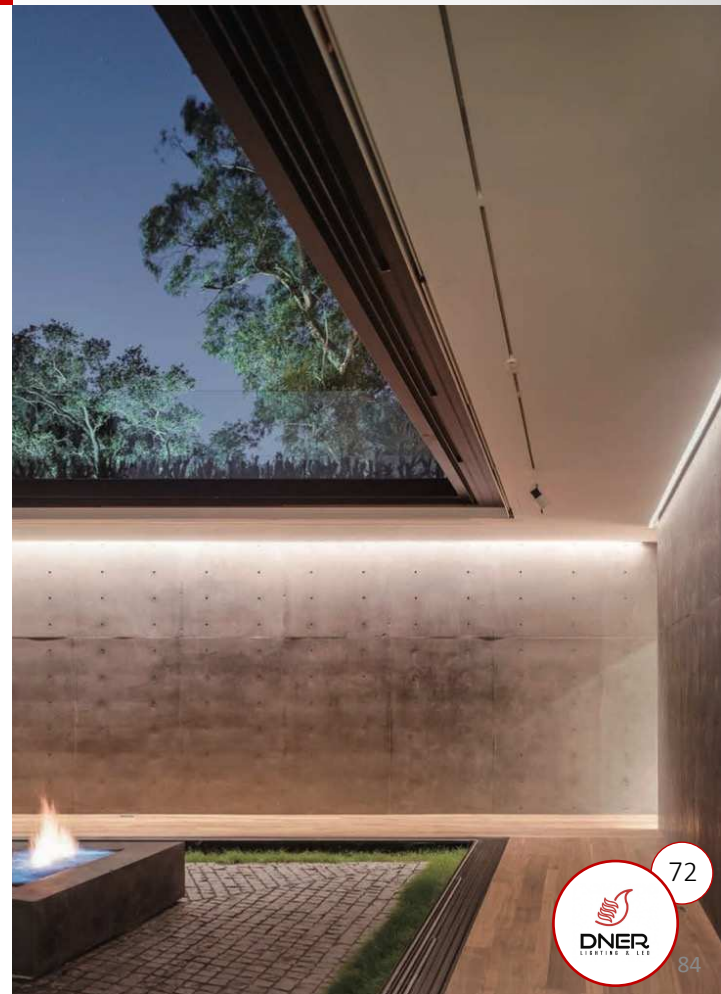

ALUMINUM PROFILE SET

For LED Strip light

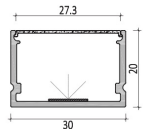

XQ-121-M3020 1M / XQ-121-M3020 2M

L : 1000mm. / 2000mm.

PCB : 12mm.

Unit price : 415 THB / 830 THB

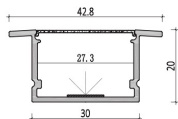

XQ-180-Y4320 1M / XQ-180-Y4320 2M

L : 1000mm. / 2000mm.

PCB : 12mm.

Unit price : 430 THB / 860 THB

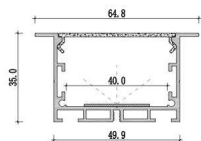

HC 640 1M / HC 640 2M

L : 1000mm. / 2000mm.

PCB : 12mm.

Unit price : 900 THB / 1800 THB

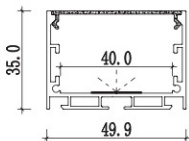

HC 641 1M / HC 641 2M

L : 1000mm. / 2000mm.

PCB : 12mm.

Unit price : 875 THB / 1715 THB

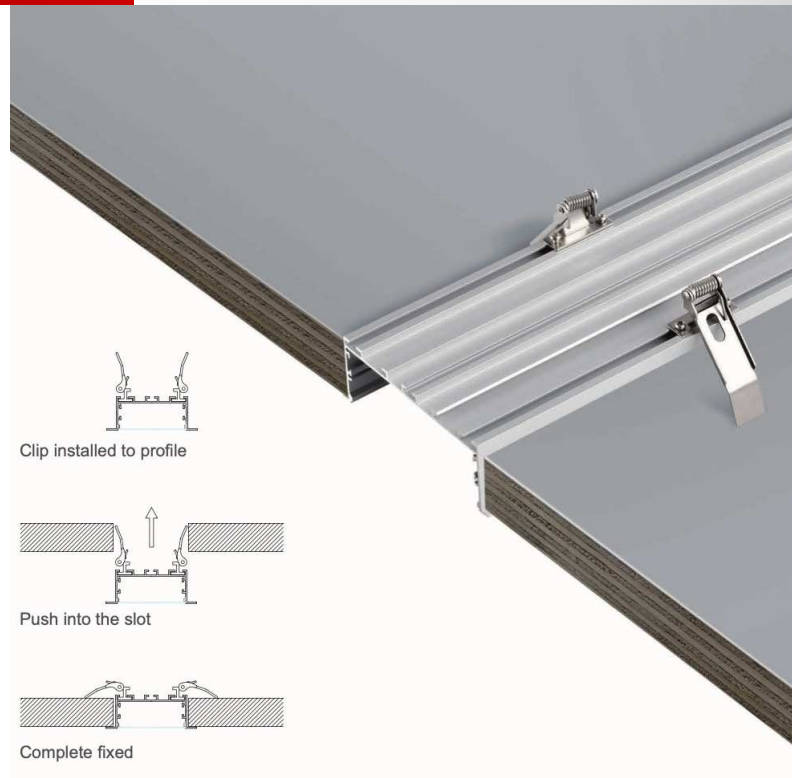

Clip installed to profile

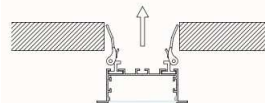

Push into the slot



Complete fixed

ALUMINUM PROFILE SET

For LED Strip light

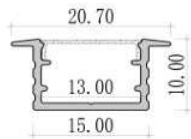

CY610 2M

L : 2000mm.

PCB : 5.5-10mm.

Unit price : 315THB

NEW!
2m.
Length



Installation steps

-1

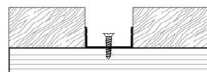

-2

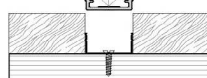

-3

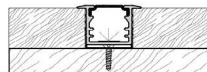

Recessed series
Corner linear fixture

102



NEW! - GOOD PRICE!

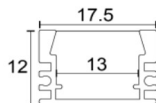

FL1712 1M / FL1712 2M

L : 1000mm. / 2000mm.

PCB : 13mm.

Unit price : 122 THB / 243 THB

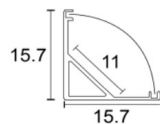

FL1616 1M / FL1616 2M

L : 1000mm. / 2000mm.

PCB : 11mm.

Unit price : 86 THB / 172 THB

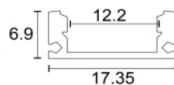

FL1707 1M / FL1707 2M

L : 1000mm. / 2000mm.

PCB : 12.2mm.

Unit price : 93 THB / 186 THB

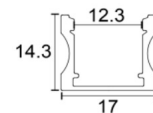

FL1714 2M

2000mm.

PCB : 10mm.

Unit price : 200 THB

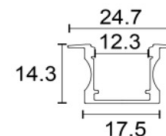

FL2414 2M

2000mm.

PCB : 10mm.

Unit price : 230 THB

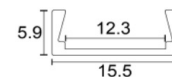

FL1606 1M / FL1606 2M

L : 1000mm. / 2000mm.

PCB : 12.3mm.

Unit price : 86 THB / 172 THB

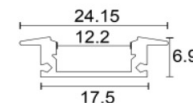

FL1708 1M / FL1708 2M

L : 1000mm. / 2000mm.

PCB : 12.2mm.

Unit price : 108 THB / 215 THB

รางอลูมิเนียมพร้อมซิลิโคนครอบ สำหรับฝังงาน

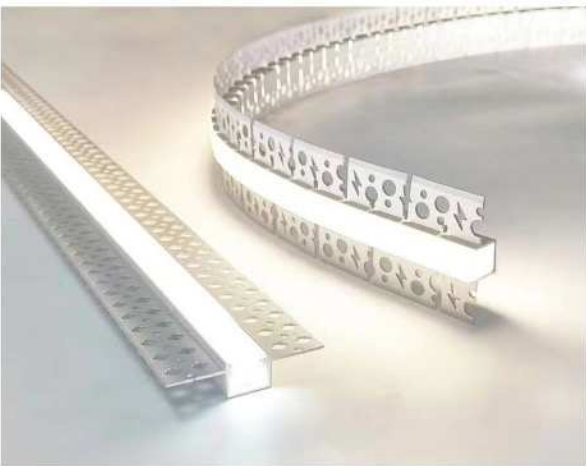

XL125M1

รางตรง 1 เมตร

Size : W52.5 x H13mm.

L : 1m.

Unit price : 430 THB

XL125M2

รางตรง 2 เมตร

Size : W52.5 x H13mm.

L : 2m.

Unit price : 860 THB

XL5513M1

รางตัดโค้ง 1 เมตร

Size : W52.5 x H13mm.

L : 1m.

Unit price : 500 THB

XL5513M2

รางตัดโค้ง 2 เมตร

Size : W52.5 x H13mm.

L : 2m.

Unit price : 1000 THB

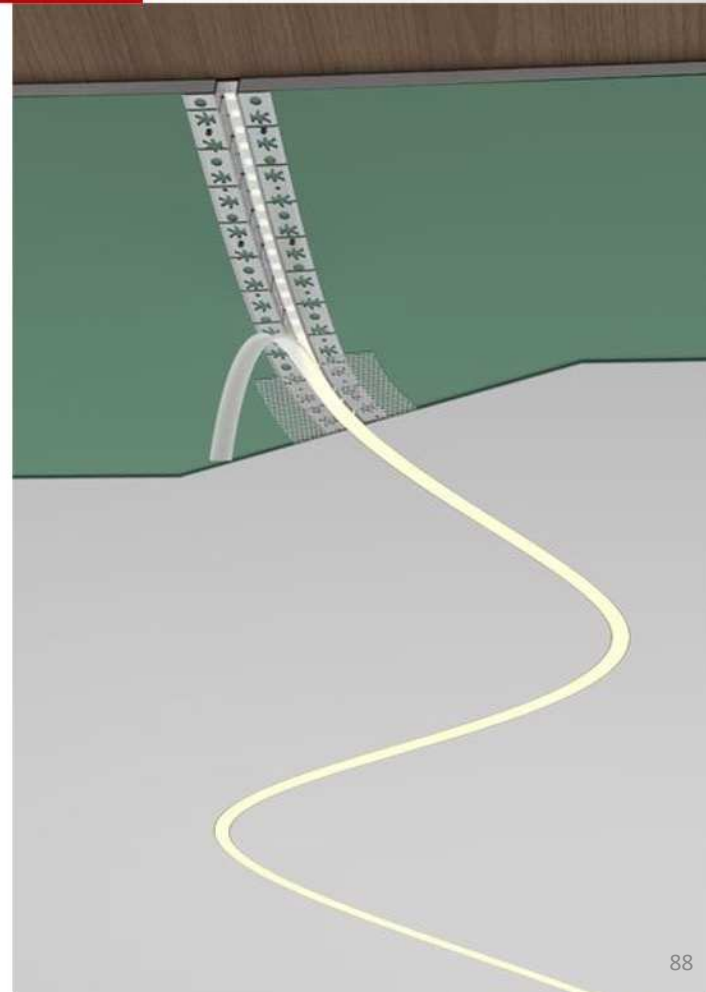
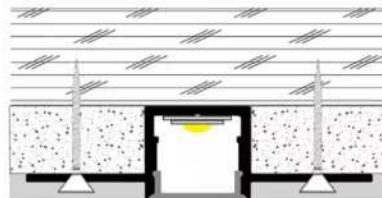
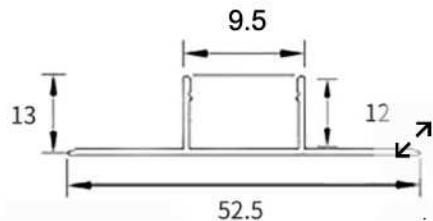

ALUMINUM PROFILE SET

For LED Strip light

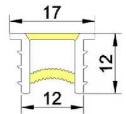
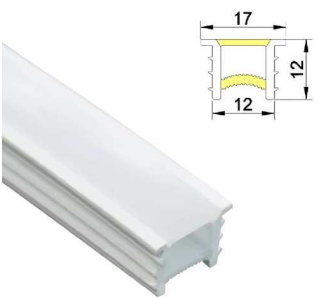

Silicone Cover
SLY1212

Size : W17 x H12mm.
Roll : L200m.
Unit price : Roll 17750 THB
Cut 5m. 1080 THB

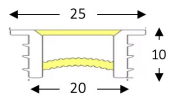
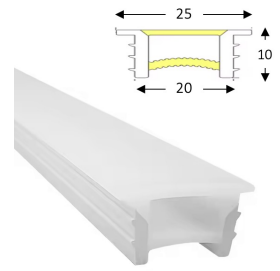

Silicone Cover
SLY2010

Size : W25 x H10mm.
Roll : L100m.
Unit price : Roll 25720 THB
Cut 5m. 1790 THB

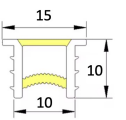
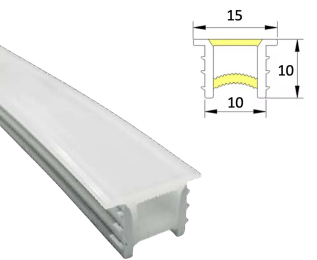

Silicone Cover
SY1010

Size : W10 x H10mm.
Roll : L200m.
Unit price : Roll 14290 THB
Cut 5m. 575 THB

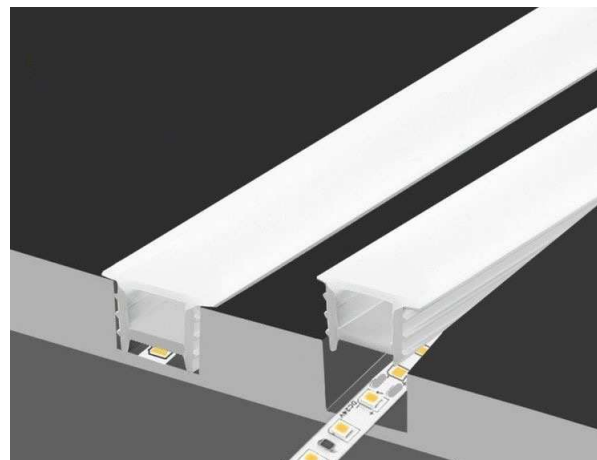

ALUMINUM PROFILE COMPLETE SET

Power Supply for Aluminum ribbon set



MHDR2412

12V

24W

Unit price : 430 THB

MHDR3612

12V

36W

Unit price : 500 THB

MHDR6012

12V

60W

Unit price : 690 THB

MHDR10012

12V

100W

Unit price : 930 THB

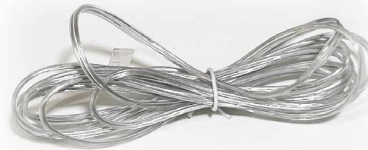

MH100SPLUG

ปลั๊กสายต่อรุ่น100S/1010S

L : 1.85m.

Unit price : 43 THB

MH1616YPLUG

ปลั๊กสายต่อรุ่น1616Y

L : 1.85m.

Unit price : 43 THB

หัวปลั๊กต่อไฟ
ไม่ต้องบัดกรี



SENSOR SWITCH

Touch / Dimming switch

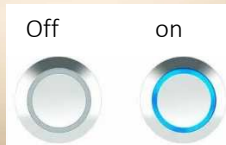

CMJK01 : Touch Switch

แบบต่อพ่วงหลายจุด

Unit price : 345 THB



CMFK02 : Touch Switch

แบบต่อแยกจุด

Unit price : 345 THB

Sensor switch



DNMK601 : Single Sensor Switch

Size : Dia.12x12mm.

12VDC 60W - 24VDC 100W

Unit price : 360 THB



DNSK602 : Double Sensor Switch

Size : Dia.12x12mm.

12VDC 60W - 24VDC 100W

Unit price : 460 THB

WARDROBE SWITCH



DNMK301 : Single Sensor Switch

Size : Dia.15x20mm.

Unit price : 372 THB



DNSK302 : Double Sensor Switch

Size : 42x 8x20mm.

Unit price : 486 THB



YK-BTMK001BK : Single Sensor Switch

Black color

Size : Dia.12 x 30mm.

Unit price : 375 THB



YK-BTMK001WH : Single Sensor Switch

White color

Size : Dia.12 x 30mm.

Unit price : 375 THB



WARDROBE SWITCH



สวิตช์ตู้เสื้อผ้า

DNYGS002WH / DNYGS002BK

Unit price : 260 THB



สวิตช์ตู้เสื้อผ้า

DNSW01WH / DNSW01BK

Unit price : 260 THB

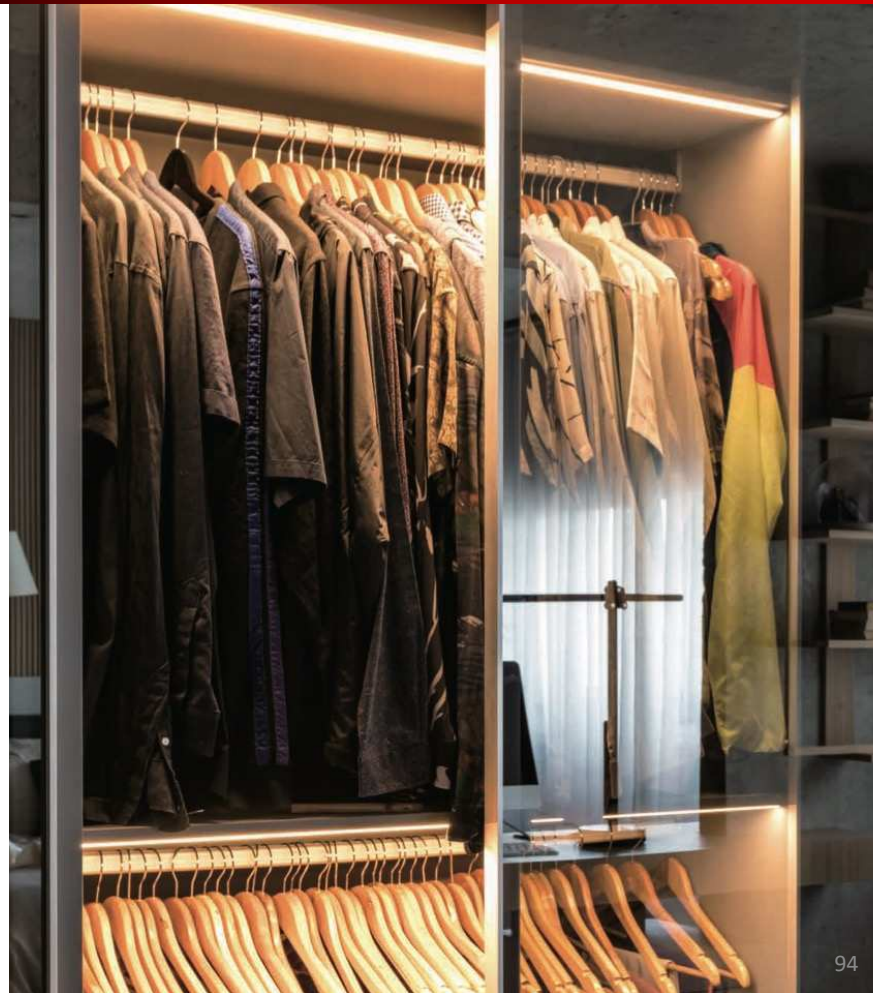

ALUMINUM PROFILE SET

Lighting Idea

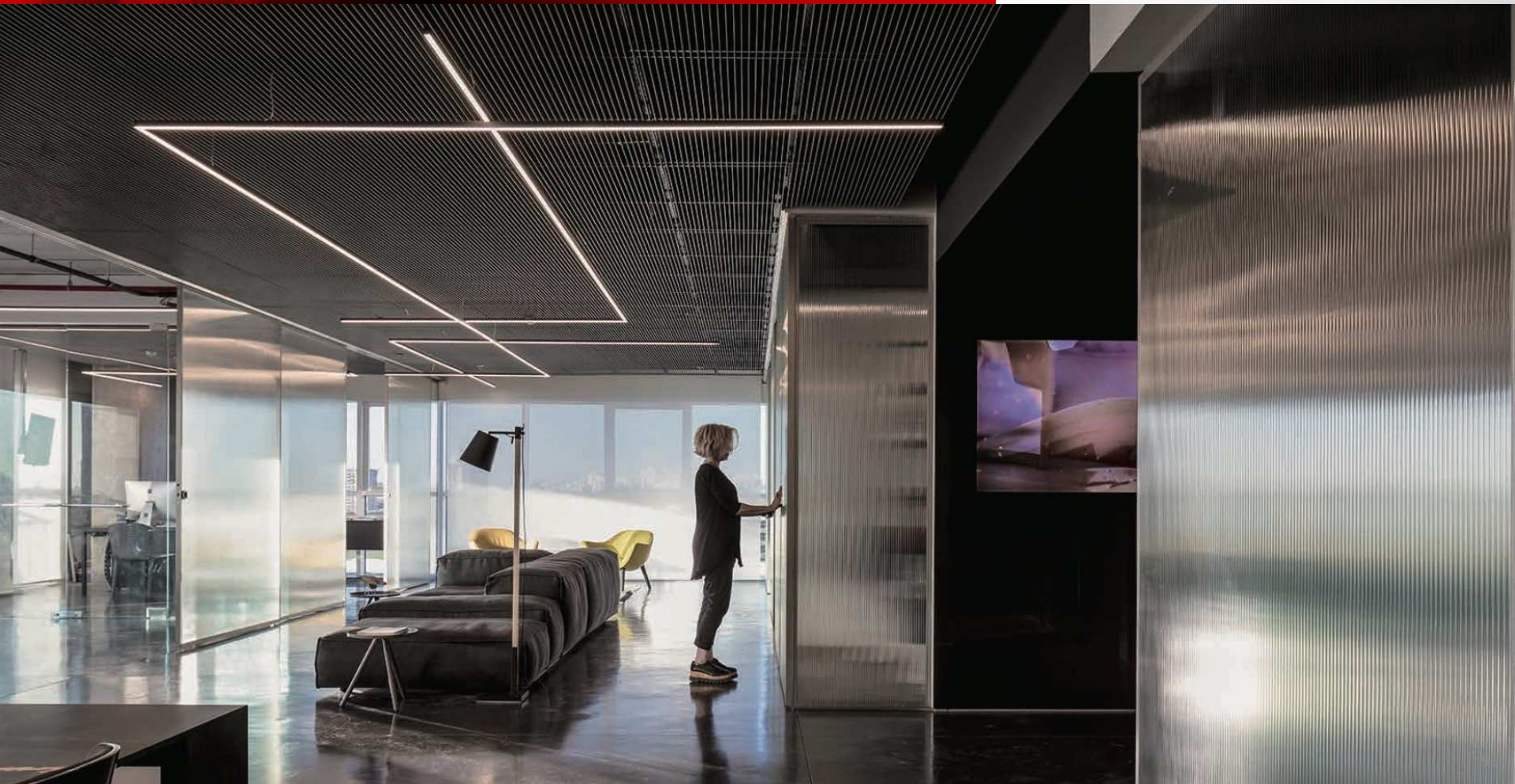



LED NEONFLEX & ROPE LIGHT

LED NEON FLEX

12
Vdc

2835 SMD 10W

Single color

LED CHIP : 2835 120 leds

VOLTAGE : 12V

WATTS : 10W/m.

DIMENSION : W9 x H16mm.

LUMENS : 390lm./m.

BEAM ANGLE : 120D

CUTTING : 2.5cm.

IP RATING : IP54

Roll : **50m.**

Price : 7,500 THB



Accessories set

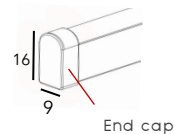

End cap

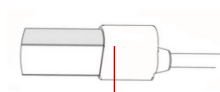

Power feed

DN11A087

Red

DN11A088

Yellow Gold

DN11A089

White

DN11A090

Green

DN11A091

Blue

DN11A092

Warm white

DN11A093

Pink

DN11A095

Violet

DN11A096

Yellow Orange

DN11A097

Ice Blue

DN11A110

Natural light



12
Vdc



2835 SMD 10W

LED CHIP : 2835 120 leds

VOLTAGE : 12V

WATTS : 10W/m.

DIMENSION : W6 x H12mm.

LUMENS : 450lm./m.

BEAM ANGLE : 120D

CUTTING : 2.5cm.

IP RATING : IP54

Roll : 50m.

Price : 6,580 THB

DN11A103 *White*

DN11A104 *Warm white*

DN11A105 *Natural light*

Mini
size
6mm.

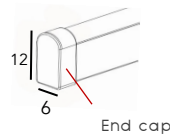

LED NEON FLEX

2835 SMD 10W

LED CHIP : 2835 120 leds

VOLTAGE : 24V

WATTS : 10W/m.

DIMENSION : W9 x H16mm.

LUMENS : 400lm./m.

BEAM ANGLE : 120D

CUTTING : 5 cm.

IP RATING : IP54

Roll : 50m.

Price : 11,500 THB

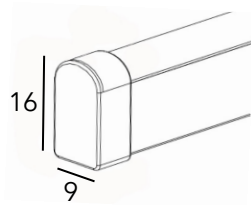

DN11A108 *White*

DN11A003 *Warm white*

DN11A004 *Natural light*



Accessories set



LED NEON FLEX

5050 SMD 14.4W RGB PIXEL

LED CHIP : 5050 RGB Pixel

VOLTAGE : 24V

WATTS : 14.4W/m.

DIMENSION : W10 x H20mm.

LUMENS : 470lm./m.

BEAM ANGLE : 120D

CUTTING : 10 cm.

IP RATING : IP54

Roll : 50m.

Price : 47,200 THB

DN11A005
28111C

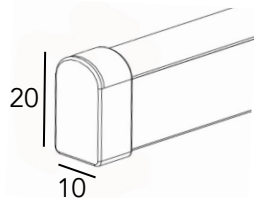
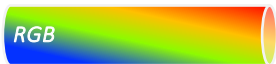

Accessories set



LED NEON FLEX

5050 SMD 14.4W
RGB 3 in 1

LED CHIP : 5050 RGB

VOLTAGE : 24V

WATTS : 14.4W/m.

DIMENSION : W10 x H20mm.

LUMENS : 470lm./m.

BEAM ANGLE : 120D

CUTTING : 50 cm.

IP RATING : IP54

Roll : 100m.

Price : 25,715 THB

DN11A006 RGB

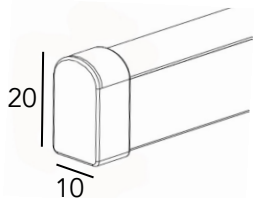
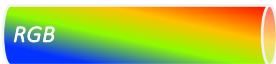

24
Vdc

100
m.

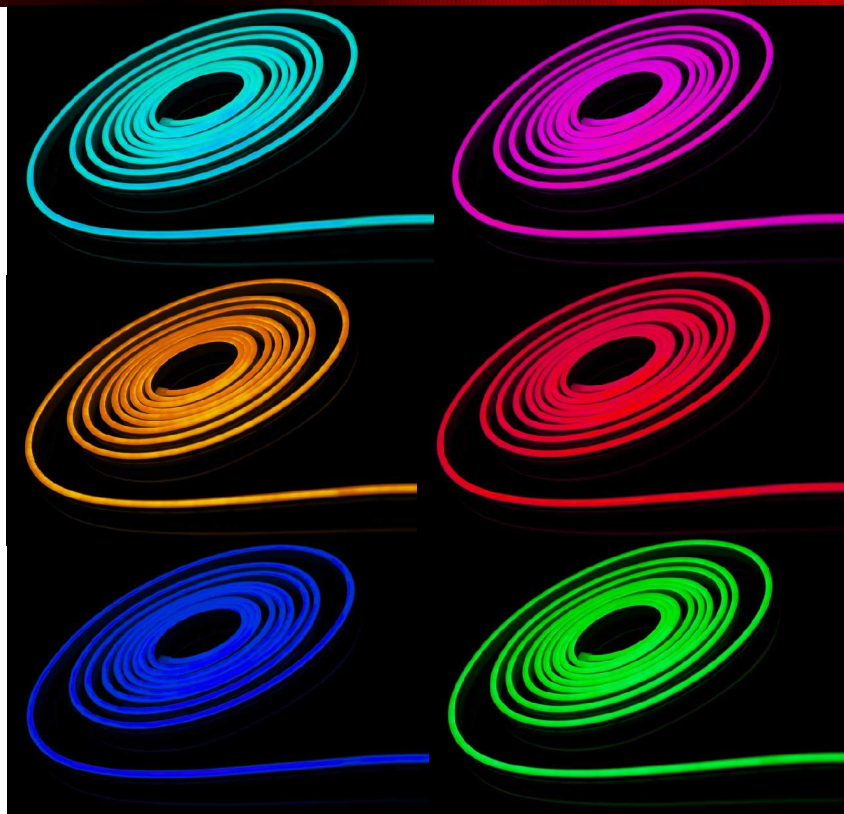



2835 SMD 10W – 50m.

High Lumens

LED CHIP : 2835 120 leds

VOLTAGE : 220V

WATTS : 10W/m.

DIMENSION : W9 x H16mm.

LUMENS : 550lm./m.

BEAM ANGLE : 120D

CUTTING : 100cm.

IP RATING : IP54

Roll : 50m.

Price : 6,860 THB

* DN11A014 / DN11A015 / DN11A016 / DN11A888

Price : 7150 THB

DN11A007 *Red*



DN11A008 *Yellow lime*



DN11A009 *White*

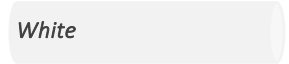

DN11A010 *Green*



DN11A011 *Blue*



DN11A012 *Warm white*

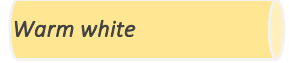

DN11A013 *Orange*



DN11A014 *Pink*



DN11A015 *Violet*



DN11A016 *Natural light*

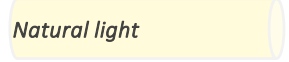

DN11A888 *Ice Blue*

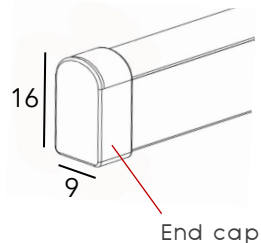
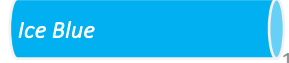

LED NEON FLEX



2835 SMD 10W – 100m.

High Lumens

LED CHIP : 2835 120 leds

VOLTAGE : **220V**

WATTS : 10W/m.

DIMENSION : W8 x H16mm.

LUMENS : 550lm./m.

BEAM ANGLE : 120D

CUTTING : 100cm.

IP RATING : IP54

Roll : **100m.**

Price : 9,430 THB

* DN11A023 / DN11A025 / DN11A026

Price : 10,000 THB

DN11A017 *Red*



DN11A018 *Orange*



DN11A109 *Yellow Lime*

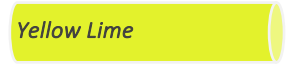

DN11A019 *White*

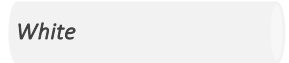

DN11A020 *Green*



DN11A021 *Blue*



DN11A022 *Warm*



DN11A023 *Pink*



DN11A025 *Violet*



DN11A026 *Ice Blue*

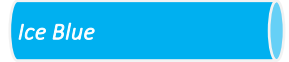

DN11A107 *Natural*

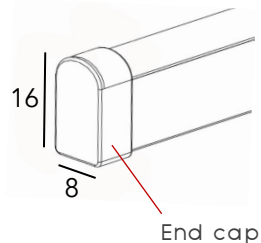
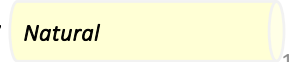

LED NEON FLEX

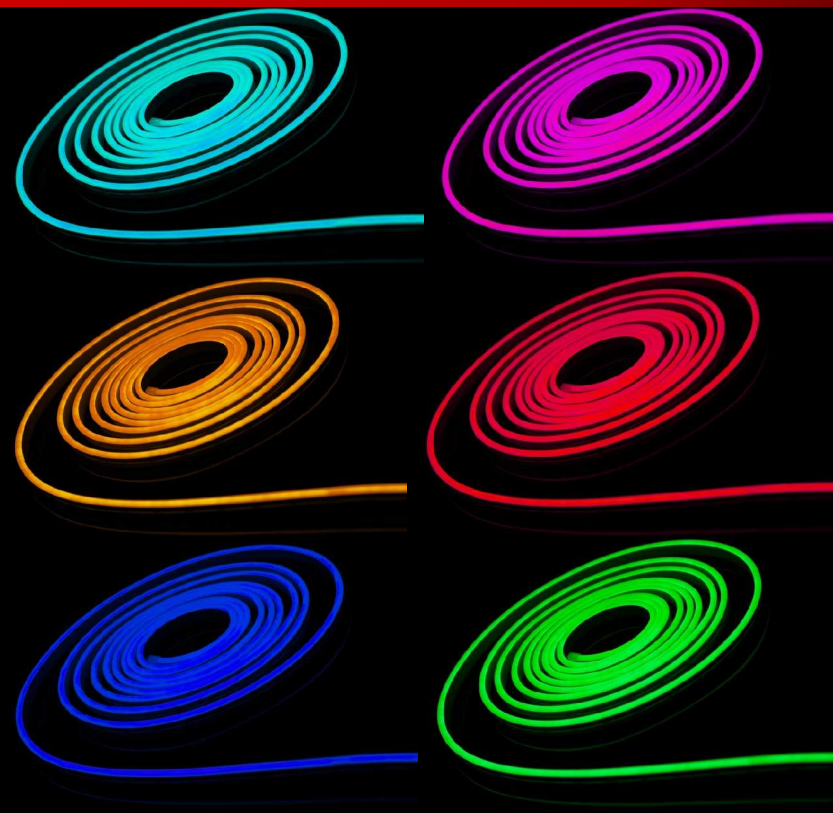

220
Vac

100
m.

2835 SMD 10W RGB 3in1

LED CHIP : 2835 120 leds

VOLTAGE : 220V

WATTS : 10W/m.

DIMENSION : W10 x H20mm.

LUMENS : 500lm./m.

BEAM ANGLE : 120D

CUTTING : 100cm.

IP RATING : IP54

Roll : 100m.

Price : 20,000 THB

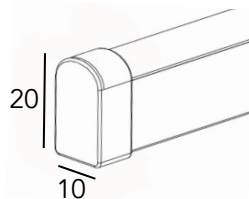

DN11A027 RGB



LED NEON FLEX

2835 SMD 10W 360D TUBE

LED CHIP : 2835 120 leds

VOLTAGE : 220V

WATTS : 10W/m.

DIMENSION : Dia.14mm.

LUMENS : 400lm./m.

BEAM ANGLE : 360D

CUTTING : 100 cm.

IP RATING : IP54

Roll : 100m.

Price : 12,860 THB

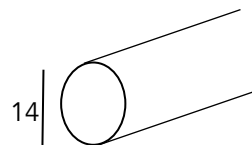

100
m.

Accessories set



DN11A028 *Warm white*

DN11A029 *Natural light*

DN11A030 *White*

220
Vac

360D GLOW

DOTLESS TUBE

LED RIBBON COB



**COB
Series**



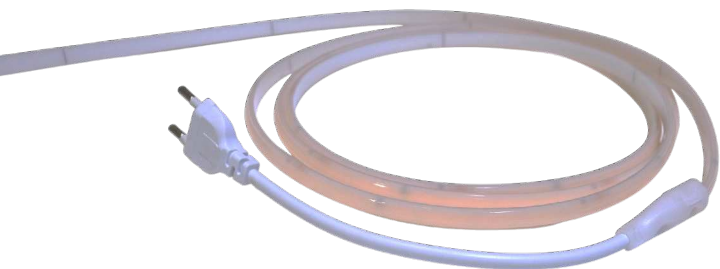

COB FROSTED RIBBON

LED CHIP : 288leds

VOLTAGE : 220Vac

WATTS : 9W/m.

DIMENSION : W10 x H5mm.

LUMENS : 900 lm./m.

BEAM ANGLE : 120D

CUTTING : 50 cm.

IP RATING : IP54

Roll : 100m.

Price : 7890 THB

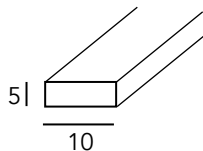

220
Vac

100
m.

DN11A122WH *White*

DN11A122WW *Warm white*

DN11A122NL *Natural light*

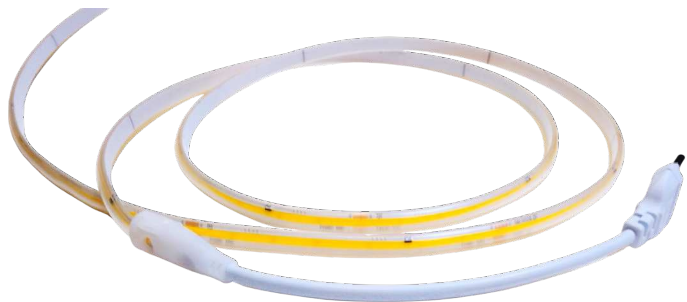

COB CLEAR RIBBON

LED CHIP : 296leds

VOLTAGE : 220Vac

WATTS : 10W/m.

DIMENSION : W10 x H6mm.

LUMENS : 900 lm./m.

BEAM ANGLE : 120D

CUTTING : 12.5 cm.

IP RATING : IP54

Roll : 100m.

Price : 7,150 THB

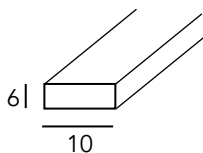

220
Vac

100
m.

DN11A118 *Warm white*

DN11A119 *Natural light*

DN11A120 *White*

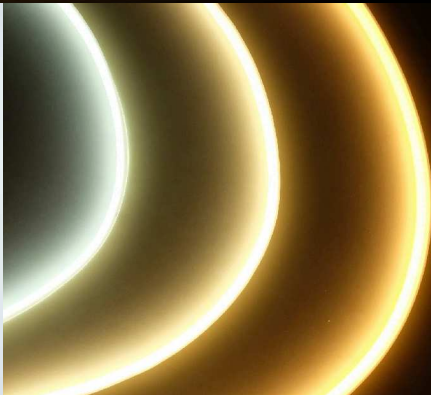

COB FROSTED RIBBON

LED CHIP : 288leds

VOLTAGE : 220Vac

WATTS : 9W/m.

DIMENSION : W10 x H5mm.

LUMENS : 900 lm./m.

BEAM ANGLE : 120D

CUTTING : 50 cm.

IP RATING : IP54

Roll : 50m.

Price : 9,300 THB

220
Vac

50
m.

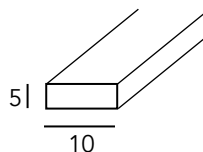

DN11A115 *White*

DN11A116 *Warm white*

DN11A117 *Natural light*



DOTLESS LINEA



COB CLEAR RIBBON

LED CHIP : 288leds

VOLTAGE : 220Vac

WATTS : 9W/m.

DIMENSION : W13 x H6mm.

LUMENS : 900 lm./m.

BEAM ANGLE : 120D

CUTTING : 50 cm.

IP RATING : IP54

Roll : 50m.

Price : 9,300 THB

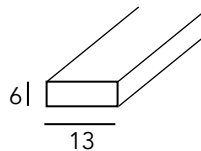

220
Vac

50
m.

DN11A112 *White*

DN11A113 *Warm white*

DN11A114 *Natural light*

LED ROPE LIGHT

NEW!
220V



‘No-Driver’



2835-120P-220VDirect

LED CHIP : 2835 120 leds

VOLTAGE : 220Vac

WATTS : 8W/m.

DIMENSION : W10 x H3mm.

LUMENS : 800 lm./m.

BEAM ANGLE : 120D

CUTTING : 10 cm.

IP RATING : IP54

Roll : 10m.

Price : 1,290 THB/roll

220
Vac

10
m.

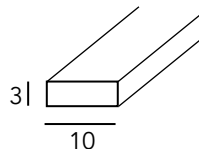

DNRB220VDI-WH *White*

DNRB220VDI-WW *Warm white*

DNRB220VDI-NL *Natural light*

LED ROPE LIGHT



2835 Triple line SMD

LED CHIP : 2835 180 leds

VOLTAGE : 220Vac

WATTS : 13W/m.

DIMENSION : W17 x H7mm.

LUMENS : 500 lm./m.

BEAM ANGLE : 120D

CUTTING : 100 cm.

IP RATING : IP54

Roll : 100m.

Price : 10,000 THB

220
Vac

100
m.

DN11A031 *White*

DN11A032 *Warm white*

DN11A033 *Natural light*

DN11A034 *Blue*

LED ROPE LIGHT



2835 Triple line SMD

LED CHIP : 2835 180 leds

VOLTAGE : 220Vac

WATTS : 13W/m.

DIMENSION : W17 x H7mm.

LUMENS : 500 lm./m.

BEAM ANGLE : 120D

CUTTING : 100 cm.

IP RATING : IP54

Roll : 50m.

Price : DN11A035 = 5,450 THB

DN11A036 = 5,450 THB

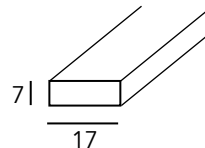

220
Vac

50
m.

DN11A035 *RGB 14.4W*

DN11A036 *Blue 13W*

LED ROPE LIGHT



220
Vac

50
m.

5050 SMD Single color

LED CHIP : 5050 60 leds

VOLTAGE : 220V

WATTS : 14.4W/m.

DIMENSION : W14 x H7mm.

LUMENS : 500 lm./m.

BEAM ANGLE : 120D

CUTTING : 100 cm.

IP RATING : IP54

Roll : 50m.

Price : 6,000 THB

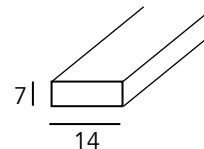

DN11A041 *Red*

DN11A042 *Orange*

DN11A043 *White*

DN11A044 *Green*

DN11A045 *Blue*

DN11A046 *Warm white*

DN11A047 *Natural light*

DN11A048 *Pink*

LED ROPE LIGHT



220
Vac

50
m.

5050 SMD RGB

LED CHIP : 5050 60 leds
VOLTAGE : 220V
WATTS : 14.4W/m.
DIMENSION : W14 x H7mm.
LUMENS : 500 lm./m.
BEAM ANGLE : 120D
CUTTING : 100 cm.
IP RATING : IP54
Roll : 50m.
Price : 6,430 THB

DN11A049 RGB 14.4W

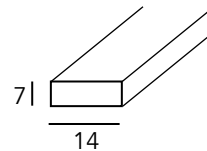

LED ROPE LIGHT



220
Vac

100
m.

5050 SMD RGB Double 96 leds

LED CHIP : 5050 192 leds

VOLTAGE : 220V

WATTS : **28.8W/m.**

DIMENSION : W14 x H7mm.

LUMENS : 500 lm./m.

BEAM ANGLE : 120D

CUTTING : 100 cm.

IP RATING : IP54

Roll : 100m.

Price : 12,900 THB

DN11A111

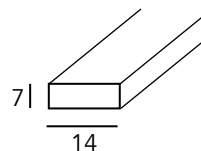

LED ROPE LIGHT



220
Vac

100
m.

5050 SMD 8mm.

LED CHIP : 5050 60 leds

VOLTAGE : 220Vac

WATTS : **14.4W/m.**

DIMENSION : W11 x H6mm.

LUMENS : 450 lm./m.

BEAM ANGLE : 120D

CUTTING : 100 cm.

IP RATING : IP54

Roll : **100m.**

Price : **7,580 THB**

DN11A051 *White*

DN11A052 *Blue*

DN11A053 *Warm white*

DN11A054 *Natural light*

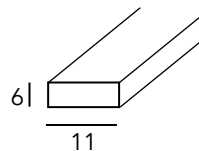



DN11A066
Ribbon 5050 Power Cable set
 For Ribbon size : 14 x 7mm.
 220V
 Unit Price : 87 THB



DN11A069
Ribbon Double line Power Cable set
 For Ribbon size : 17 x 7mm.
 220V
 Unit Price : 95 THB



DN11A069-1
COB Ribbon Power Cable set
 For Ribbon size : 13 x 6mm.
 220V
 Unit Price : 100 THB



220VDIPLUG
 Power Cable
 For Clear Ribbon 220V
 Unit Price : 75 THB



DN11A067
Neonflex Power Cable set
 For Neonflex size : 16 x 8mm.
 220V
 Unit Price : 87 THB



DN11A068
Neonflex TUBE Power Cable set
 For Neonflex size : Dia.13mm.
 220V
 Unit Price : 100 THB



DN11A070
Neonflex 12/24V Power Cable set
 For Neonflex size : 14 x 7mm.
 Unit Price : 75 THB



DN11A071
Neonflex 12/24V RGB Power Cable set
 For Neonflex size : 14 x 7mm.
 Unit Price : 80 THB

ACCESSORIES



DN11A080

ตัวต่อกลาง 2835 2 1ส
Unit Price : 29 THB



DN11A081

ตัวต่อกลาง 2835 4 1ส
Unit Price : 29 THB



DN11A082

ชุดเข็มต่อกลาง Neonflex
10 ชุด / bag
Unit Price : 145 THB



DN11A101

กิ๊ปล็อค Tube / Neonflex
Unit Price : 20 pcs / 58 THB



DN11A085

Aluminum Profile for Neon flex
1m.
Unit Price : 215 THB



DN11A098

ตัวต่อกลาง 5050
Unit Price : 25 THB



DN11A099

กิ๊ปล็อค Ribbon size: 14 x 7mm.
20 pcs. / bag
Unit Price : 90 THB



DN11A100

กิ๊ปล็อค Ribbon size: 10 x 7mm.
20 pcs. / bag
Unit Price : 60 THB



DN11A084

Aluminum lock for Neon flex
50mm.
Unit Price : 30 THB



DN11A086

Plastic Profile for Neon flex
1m.
Unit Price : 90 THB



COB6802

ตัวต่อกลางรีบบิ้น COB IP65
5 pcs. / pack
Unit Price : 86 THB



CLIPCRB

กิ๊ปล็อค COB หน้าขุ่น
20 pcs. / bag
Unit Price : 58 THB



GLIP508MM

กิ๊ปล็อค 8mm. / 5050 / COB ใส
20 pcs. / bag
Unit Price : 72 THB



GLIPC10MM

กิ๊ปล็อคสายยาว 5050 RGB
20 pcs. / bag
Unit Price : 72 THB



CLIP612

กิ๊ปล็อค neonflex 6mm.
20 pcs. / bag
Unit Price : 72 THB



ZJVDI05

ตัวต่อกลางไฟสายยาว
Unit Price : 36 THB



ZJCOB013

ตัวต่อกลางรีบบิ้น COB
Unit Price : 36 THB

RGB STRIPLIGHT CONTROLLER



DN8A066
SP108E WIFI
Controller For Strip 2811, 2818
DC5-24V
Unit Price : 2000 THB



DN8A067
SP107E WIFI
Controller For Strip 2811, 2818
DC5-24V
Unit Price : 1715 THB



SP901E
Signal Amplifier
Input Voltage : DC24V
Signal : 5V
Consumption : <1W
Unit Price : 1000 THB



DN8A068
SP105E Bluetooth
Controller For Strip 2811, 2818
DC5-24V
Unit Price : 1075 THB



DN8A065
Controller For Strip 2811
10-15 rolls
Unit Price : 290 THB



SP608E
8 Output Pixel LED Controller
DC5-24V Trigger
Unit Price : 3430 THB

RGB STRIPLIGHT CONTROLLER



DN8A064
LED Striplight Controller
Single light
10A*3CH 360W
Unit Price : 500 THB



DNWIFIRGB1221
RGB Controller For Strip 12V
21 programs
Unit Price : 500 THB



DN11A055
RGB Controller 1500W
Ribbon 5050 / 2835
220V
Unit Price : 430 THB



DN8A056
RGB Controller
DC12V
72W
Unit Price : 130 THB



DN8A069 RGB Amplifier
12-24VDC RGB 24A
Unit Price : 430 THB



DN8A062
LED Striplight RGB Controller
10A*3CH
360W
Unit Price : 790 THB

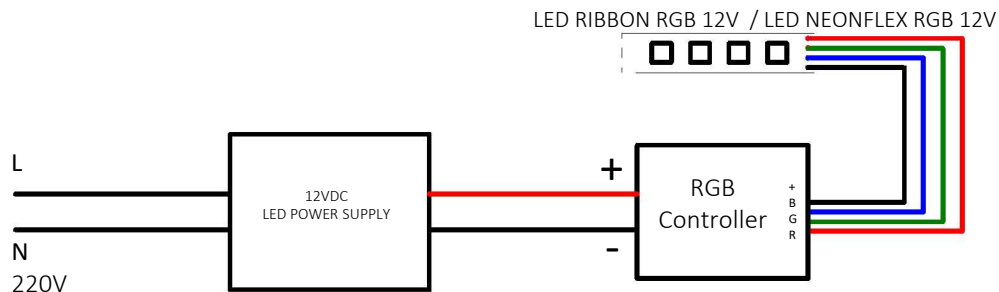

RGB RIBBON CONTROLLER



DN11A078

RGB Controller 1500W

Ribbon 5050 / 2835

220V

Unit Price : 860 THB THB



GYAPP50M

RGB Controller 750W

Bluetooth Connections

220V

Unit Price : 860 THB

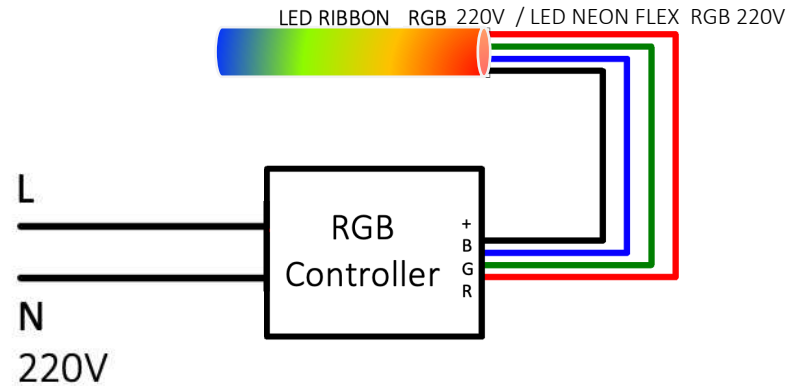

LED RIBBON DIMMER



DN8A061

Dimmer 12V – 24V
30A
Unit Price : 530 THB



DNYK1500

Dimmer 220V – 240VAC
1500W
Unit Price : 890 THB

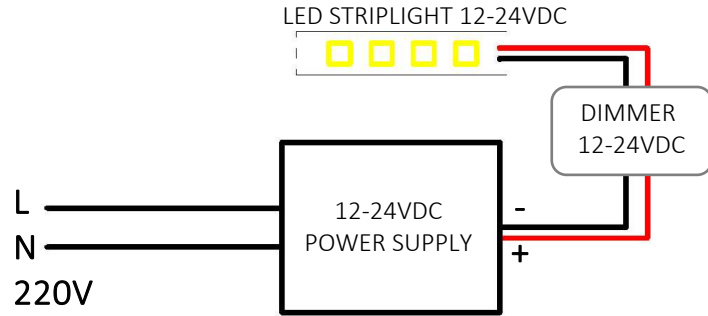



DECORATIVE LIGHTING



1006-BW / 1006-WH

Size : Dia.250 x H250mm.

Aluminum black- black inside / white

Lamp socket : 1 x E27

Voltage : 220

IP20

Unit price : 1285 THB

The price is exclude light bulb.



BOLAR 1016-BG / BOLAR 1016-WG

Size : Dia.400 x H250mm.

Aluminum black / white (Gold inside)

Lamp socket : 1 x E27

Voltage : 220

IP20

Unit price : 3430 THB



32cm.

32cm.



25cm.

38cm.



1005-BW / 1005-WH

Size : Dia.320 x H320mm.

Aluminum Black and wood (White inside)

Lamp socket : 1 x E27

Voltage : 220

IP20

Unit price : 1490 THB

*** 1005-WH : White and White inside**



1130-BG / 1130-WG

Size : Dia.380 x H250mm.

Aluminum Black (Gold inside) / White (Gold inside)

Lamp socket : 1 x E27

Voltage : 220

IP20

Unit price : 2075 THB

*** 1003-WG : White and Gold inside**



EXPLO 1029

Size : Dia.360 x H290mm.

Aluminum

Lamp socket : 1 x E27

Voltage : 220

IP20

Unit price : 1800 THB

* EXPLO 1029-WH : White and White inside

* EXPLO 1029-BB : Black and Black inside

* EXPLO 1029-BG : Black and Gold inside



EXPLO 1029A-WH

Size : Dia.360 x H290mm.

Aluminum White and wood

Lamp socket : 1 x E27

Voltage : 220

IP20

Unit price : 1900 THB



EXPLO 1029A-BW

Size : Dia.360 x H290mm.

Aluminum Black and White inside
and wood

Lamp socket : 1 x E27

Voltage : 220

IP20

Unit price : 1900 THB

* EXPLO 1029A-BB : Black and Black inside



40cm.

46cm.



BAKERY 1059 S

Size : Dia.460 x H400mm.

Aluminum Chrome and glass

Lamp socket : 1 x E27

Voltage : 220

IP20

Unit price : 7450 THB



40cm.

46cm.



BAKERY 1059 BK

Size : Dia.460 x H400mm.

Aluminum Black and glass

Lamp socket : 1 x E27

Voltage : 220

IP20

Unit price : 7450 THB



40cm.

46cm.



BAKERY 1059 G

Size : Dia.460 x H400mm.

Aluminum Gold and glass

Lamp socket : 1 x E27

Voltage : 220

IP20

Unit price : 7450 THB



40cm.

32cm.



IRON 2207

Size : Dia.320 x H400mm.

Aluminum Black and Glass

Lamp socket : 1 x E27

Voltage : 220

IP20

Unit price : 2000 THB



27cm.

30cm.



IRON 1105 BW

Size : Dia.300 x H270mm.

Steel Black and White inside

Lamp socket : 1 x E27

Voltage : 220

IP20

Unit price : 1575 THB



2851

Size : Dia.310 x H220mm.

Aluminum Black

Lamp socket : 1 x E27

Voltage : 220

IP20

Unit price : 1860 THB



2215

Size : Dia.360 x H280mm.

Aluminum Black and Glass

Lamp socket : 1 x E27

Voltage : 220

IP20

Unit price : 1145 THB

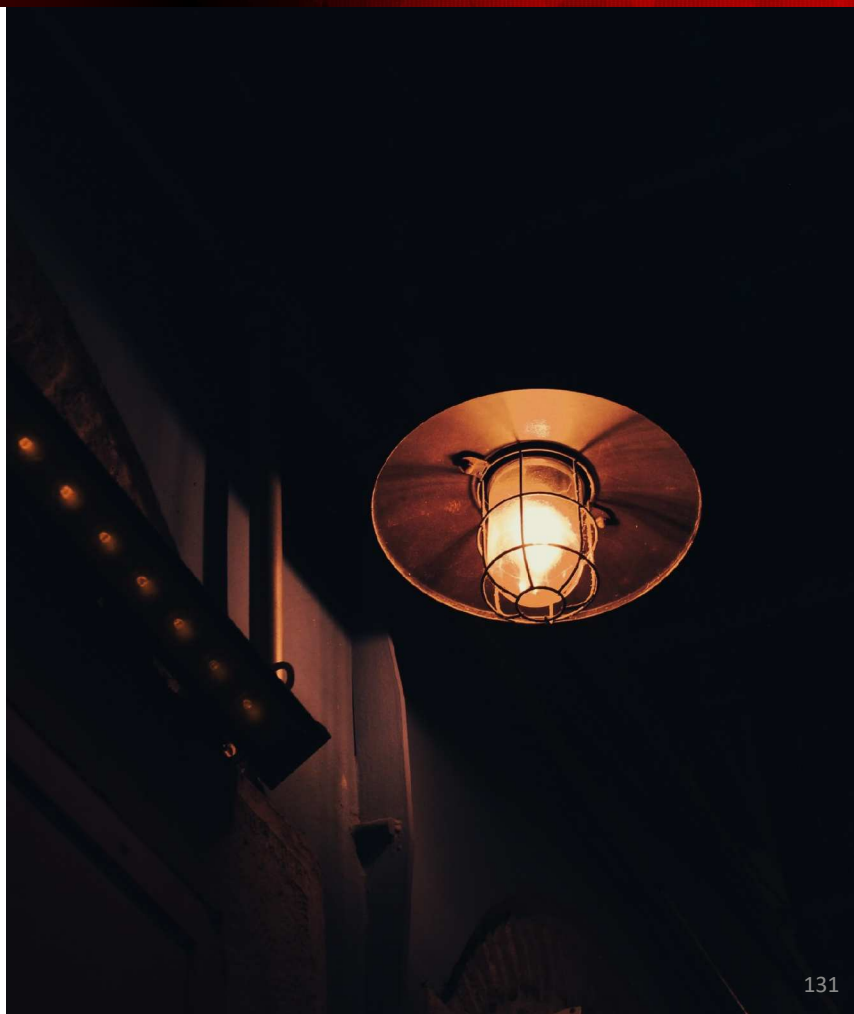



DN-2214

Size : Dia.390 x H300mm.

Aluminum Black and gold inside

Lamp socket : 1 x E27

Voltage : 220

IP20

Unit price : 2000 THB



8194/1

Size : Dia.290 x H220mm.

Aluminum Black

Lamp socket : 1 x E27

Voltage : 220

IP20

Unit price : 2190 THB



2305-BW

Size : Dia.360 x H250mm.

Aluminum Black and White inside

Lamp socket : 1 x E27

Voltage : 220

IP20

Unit price : 1600 THb

***2305-BB : Black and Black inside**





30cm.

30cm.



8004

Size : Dia.300 x H300mm.

Aluminum Black

Lamp socket : 1 x E27

Voltage : 220

IP20

Unit price : 1960 THB



33cm.

26cm.



DN-2345BB

Size : Dia.330 x H260mm.

Aluminum Black

Lamp socket : 1 x E27

Voltage : 220

IP20

Unit price : 1900 THB



33cm.

26cm.



DN-2345GT330

Size : Dia.330 x H260mm.

Aluminum Rusty color

Lamp socket : 1 x E27

Voltage : 220

IP20

Unit price : 1900 THB

*** DN-2345GT410 : Dia.410 x H390mm.**

1720 THB



13cm.

22cm.



L2210

Size : Dia.220 x H130mm.

Aluminum Black, Gold socket

Lamp socket : 1 x E27

Voltage : 220

IP20

Unit price : 575 THB



17cm.

15cm.



L0003

Size : Dia.150 x H170mm.

Steel Black

Lamp socket : 1 x E27

Voltage : 220

IP20

Unit price : 600 THB



16cm.

16cm.



2053

Size : Dia.160 x H160mm.

Steel Black

Lamp socket : 1 x E27

Voltage : 220

IP20

Unit price : 645 THB



2053-3 (Set3)

Size : Dia.160 x H200mm.

Plate : Dia.230mm.

Steel Black

Lamp socket : 3 x E27

Voltage : 220

IP20

Unit price : 2300 THB



26cm.

16cm.



L0004

Size : Dia.260 x H160mm.

Aluminum Black

Lamp socket : 1 x E27

Voltage : 220

IP20

Unit price : 460 THB



9002-1

Size : Dia.100 x H200mm.

Steel Black

Lamp socket : 1 x E27

Voltage : 220

IP20

Unit price : 430 THB



9002-3

Size : Dia.100 x H200mm.

Plate : Dia.230mm.

Steel Black

Lamp socket : 3 x E27

Voltage : 220

IP20

Unit price : 1290 THB



L0007

Size : Dia.125 x H180mm.

Steel Black

Lamp socket : 1 x E27 T125

Voltage : 220

IP20

Unit price : 375 THB



L0007-3

Size : Dia.125 x H180mm.

Plate : Dia.230mm.

Steel Black

Lamp socket : 3 x E27 T125

Voltage : 220

IP20

Unit price : 1290 THB



18cm.

20cm.



9003-3 (Set3)

Size : Dia.180 x H200mm.

Plate : Dia.230mm.

Steel Black

Lamp socket : 3 x E27

Voltage : 220

IP20

Unit price : 2290 THB



9003-1

Size : Dia.180 x H200mm.

Steel Black

Lamp socket : 1 x E27

Voltage : 220

IP20

Unit price : 645 THB





16cm.
AD012A

22cm.



13.5cm.
AD012B

22cm.



13cm.
AD012C

26cm.



AD012A

Size : Dia.160 x H220mm.

Steel Black and Amber Glass

Lamp socket : 1 x E27

Voltage : 220

IP20

Unit price : 1500 THB



AD012B

Size : Dia.135 x H220mm.

Steel Black and Amber Glass

Lamp socket : 1 x E27

Voltage : 220

IP20

Unit price : 1500 THB



AD012C

Size : Dia.130 x H260mm.

Steel Black and Amber Glass

Lamp socket : 1 x E27

Voltage : 220

IP20

Unit price : 1500 THB



25cm.

25cm.



AD019

Size : Dia.250 x H250mm.

Steel and Rope, Clear glass

Lamp socket : 1 x E27

Voltage : 220

IP20

Unit price : 2175 THB



25cm.

25cm.



AD010

Size : Dia.250 x H250mm.

Steel and Amber Glass

Lamp socket : 1 x E27

Voltage : 220

IP20

Unit price : 1600 THB



25cm.

25cm.



H025

Size : Dia.250 x H250mm.

Steel and Smoke Glass

Lamp socket : 1 x E27

Voltage : 220

IP20

Unit price : 1575 THB

*** H030 : Dia.300 x H300mm.**

2000 THB



AD021 (Set3)

Size : Dia.150, 200, 250mm.

Steel and Clear glass

Lamp socket : 3 x E27

Voltage : 220

IP20

Unit price : 3430 THB



AD022-20CM

Size : Dia.200mm.

Steel and Clear glass

Lamp socket : 1 x E27

Voltage : 220

IP20

Unit price : 1575 THB

*** AD022-25CM : Dia.250mm.**

1645 THB



25cm.



AD029

Size : Dia.250mm.

Steel and Opal milk glass

Lamp socket : 1 x E27

Voltage : 220

IP20

Unit price : 1575 THB



25cm.



AD030

Size : Dia.250mm.

Steel and Opal milk glass

Lamp socket : 1 x E27

Voltage : 220

IP20

Unit price : 2860 THB



20cm.



ALM-T20

Size : Dia.200mm.

Steel and Opal milk glass

Lamp socket : 1 x E27

Voltage : 220

IP20

Unit price : 4290 THB





ALM-3011-4

Glass Size : 2 x Dia.150mm.
2 x Dia.180mm.

Steel Gold and Clear glass

Lamp socket : 4 x G4
Voltage : 220
IP20
Unit price : 8580 THB



ALM-3011-6

Glass Size : 3 x Dia.150mm.
3 x Dia.180mm.

Steel Gold and Clear glass

Lamp socket : 6 x G4
Voltage : 220
IP20
Unit price: 10000 THB

The price is exclude light bulb.





77cm.

25cm.



AD023

Size : W300 x L770 x H250mm.

Steel and Clear glass

Lamp socket : 4 x E27

Voltage : 220

IP20

Unit price : 4290 THB

200cm.



DD-RP220

Size : Dia.100 x H2000mm.

Steel and Rope

Lamp socket : 2 x E27

Voltage : 220

IP20

Unit price : 520 THB ไม่รวมหลอดไฟ

150cm.



DD-RP115

Size : Dia.100 x H1500mm.

Steel and Rope

Lamp socket : 1 x E27

Voltage : 220

IP20

Unit price : 230 THB ไม่รวมหลอดไฟ

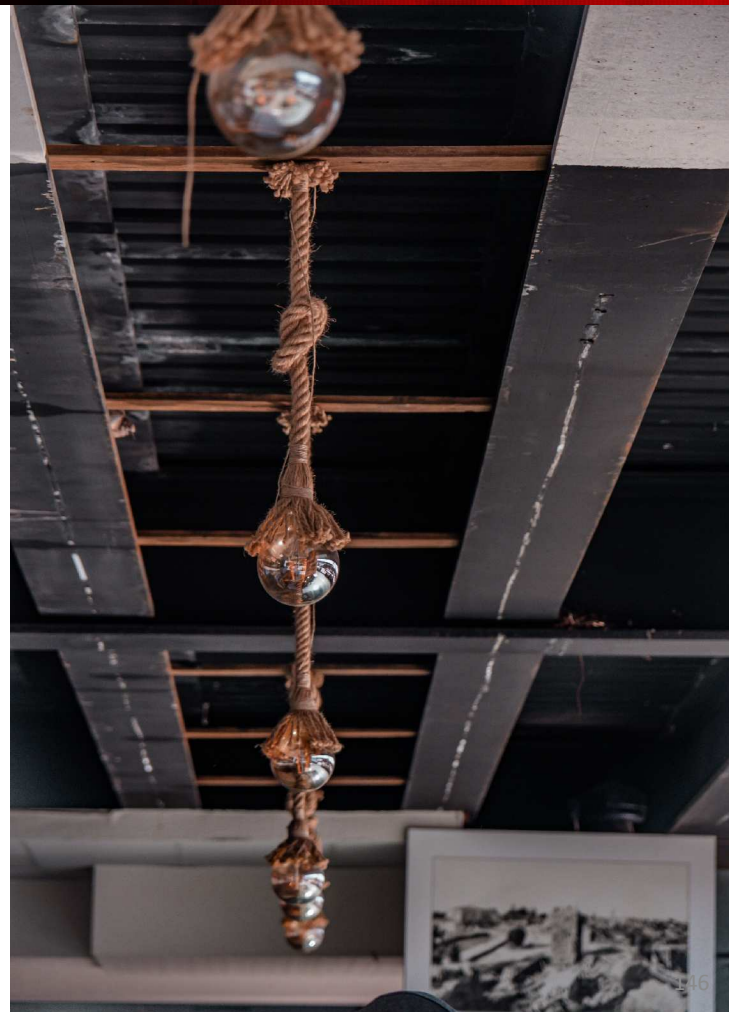



LED LINEA SUSPENSION LAMP

LINEA LED SUSPENSION LAMP

LED LINEA SUSPENSION LAMP : 3 In 1 light colors

MODEL : DN5075BK3CCT / DN5075WH3CCT

WATTS : 48W

MATERIALS : Aluminum and PC

DIMENSION : W50 x L1185 x H75mm.

CCT : 3000K / 4000K / 6500K

BEAM ANGLE : 120D

LUMEN : 4300lm.

CRI : 80

IP RATING : IP20

VOLTAGE : 175-240V

UNIT PRICE : 1590 THB



มี 3 แสงในโคมเดียว



ติดตั้งได้ทั้งแบบติดฝ้าและแบบโคมห้อย

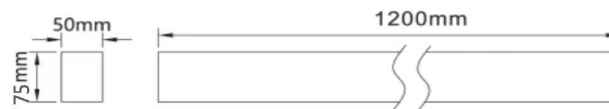



JS-6815T8-BK / JS-6815T8-WH

Aluminum Hanging lamp

Size : W70 x H80 x L1250mm.

Lamp socket : 1 x T8

Voltage : 220V

IP20

Unit price : 2000 THB ไม่รวมหลอดไฟ

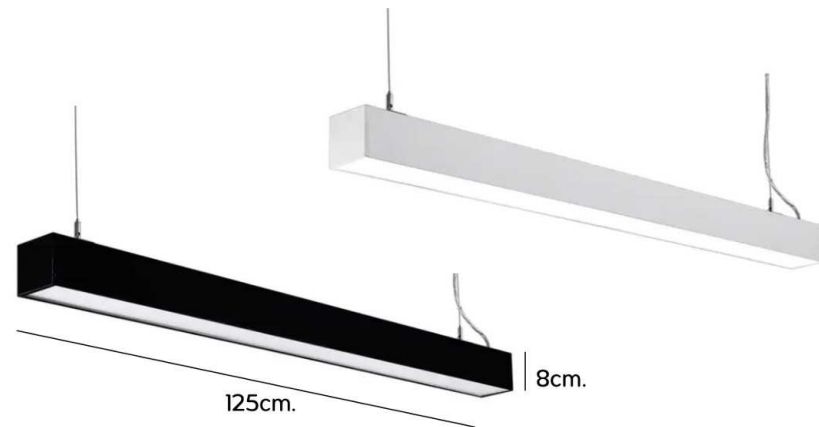



WL-G2012

Size : Dia.200 x H250mm.

Steel and Opal milk glass

Lamp socket : 1 x E27

Voltage : 220

IP20

Unit price : 3720 THB



WL-G1343

Size : Dia.130 x H430mm.

Steel gold and glass

Lamp socket : 1 x E27

Voltage : 220

IP20

Set price : 7200 THB ขายเป็นคู่



WD-MU002BK / WD-MU002WH

Size W20 x H100mm.

Steel and wood

Lamp socket : 1 x E27

Voltage : 220

IP20

Unit price : 285 THB



L0013

Size : Dia.260 x H200mm.

Steel Black color

Lamp socket : 1 x E27

Voltage : 220

IP20

Unit price : 1150 THB



VTWL0015

Size : W320 x H310mm.

Steel Black color

Lamp socket : 1 x E27

Voltage : 220

IP20

Unit price : 1290 THB



WD-B003

Size : W170 x H350mm.

Steel and Clear glass

Lamp socket : 1 x E27

Voltage : 220

IP20

Unit price : 1500 THB



SPWD06

Size : Dia.120 x H220mm.

Steel Black color

Lamp socket : 1 x E27

Voltage : 220

IP20

Unit price : 500 THB



SPWD08

Size : Dia.120 x H180mm.

Steel Black color

Lamp socket : 1 x E27

Voltage : 220

IP20

Unit price : 500 THB



DN-SL0155 / DN-BB0155

LED Reading lamp

Finished : Silver / Black

Size : Dia.63 x H400mm.

Lamp : LED 3W

Light color : Warm white

White Daylight

On-off switch on base

Voltage : 220

IP20

Unit price : 400 THB



E2

Lamp socket : 1 x E27

Canopy : Dia.10cm.

Unit price : 230 THB

สีขั้ว : ทองเงา / ทองดำน / เงินดำน / ดำดำน / ดำเงา



H2TW : Gold

Lamp socket : 1 x E27

Unit price : 400 THB



E2

Lamp socket : 1 x E27

Canopy : Dia.12cm.

Unit price : 230 THB

สีขั้ว : ทองเงา / ทองดำน / ดำเงา





3872 : Lamp Socket

Lamp socket : 1 x E27

Unit price : 230 THB

สีขั้ว : ทองรมดำ / ทองแดงพั้งค์โกลด์ / ดำเงา / ทองเหลืองรมดำ



5070 : Lamp Socket

Lamp socket : 1 x E27

Unit price : 230 THB

สีขั้ว : ทองเหลือง / ทองดำน / ทองแดงชมพู / ดำเงา / ทองแดงดำน





5070 : Brushed brass

Lamp socket : 1 x E27

Unit price : 575 THB



406P : Copper

Lamp socket : 1 x E27

Unit price : 345 THB



5077 : Lamp Socket

Lamp socket : 1 x E27

Unit price : 286 THB

สีผิว : ทอง



4876 : Lamp Socket

Lamp socket : 1 x E27

Unit price : 260 THB

สีผิว : ดำด้าน



E27 Lamp Socket

Unit price : 72 THB



E27 Lamp Socket

Single ring

Unit price : 72 THB



E27 Lamp Socket

Double ring

Unit price : 86 THB



C1WHM1 (1m.)

C2WHM2 (2m.)

Lamp Set White

Lamp socket : 1 x E27

Unit price : 1m. / 145 THB

2m./ 175 THB



C1BKM1 (1m.)

C2BKM2 (2m.)

Lamp Set Black

Lamp socket : 1 x E27

Unit price : 1m. / 145 THB

2m./ 175 THB



Canopy set 1 hole

Dia.10cm.

Unit price : 86 THB



Canopy set 3 holes

Dia.23cm.

Unit price : 575 THB



Canopy

Size : L60cm. / 345 THB

Size : L120cm. / 575 THB



อะไหล่ใช้สีดำ ยาว2m.

Unit price :215 THB

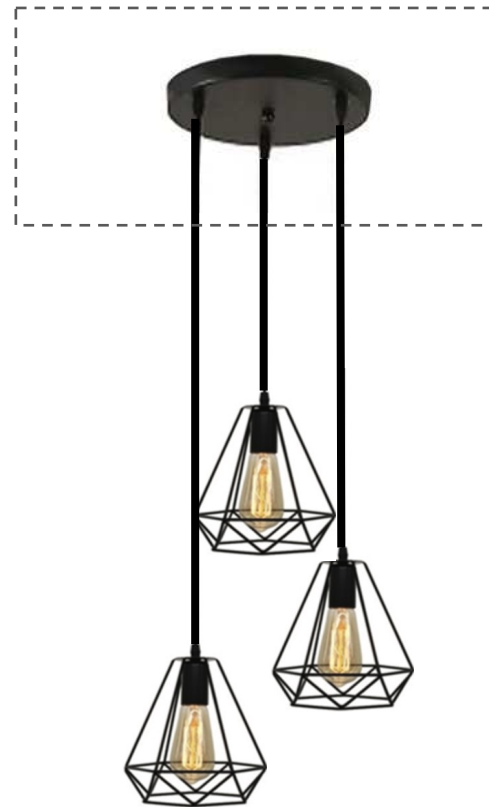



Canopy set 1 m.

BLACK สีดำ / WHITE สีขาว

ชุดสายสลิงพร้อมเบ้า ยาว1m.

Dia.5cm.

Unit price : 175 THB



Canopy set 2 m.

BLACK สีดำ / WHITE สีขาว

ชุดสายสลิงพร้อมเบ้า ยาว2m.

Dia.5cm.

Unit price : 230 THB



SLC02M

ชุดสายสลิงพร้อมเบ้า

ยาว2m.

Unit price : 230 THB

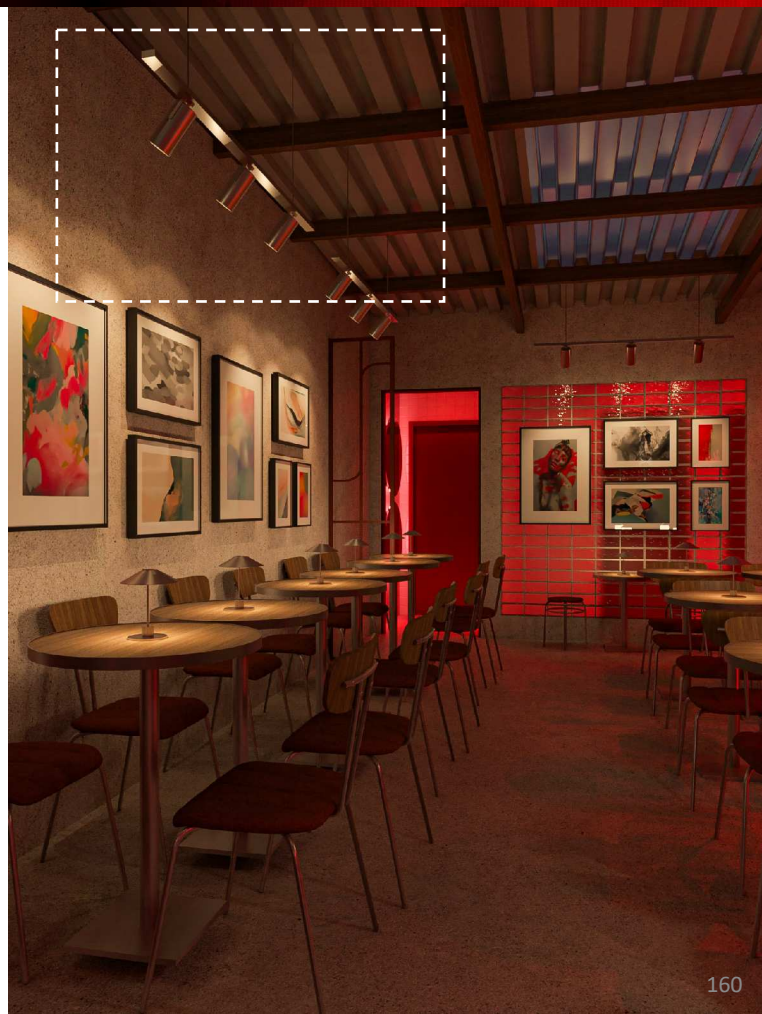

**GU10**

สายไฟยาว 20cm.

Unit price : 86 THB

**GU5.3 (MR16 หุ้มสาย)**

Unit price : 32 THB

**GU5.3 (MR16)**

Unit price : 29 THB

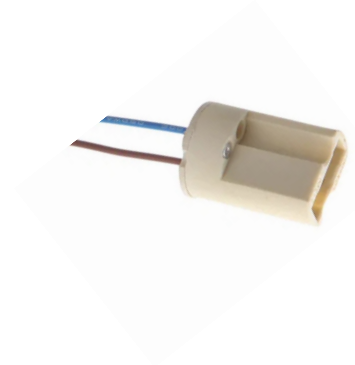
**G9 เซรามิก**

Unit price : 36 THB

**GU5.3 (MR16 Lock)**

Unit price : 32 THB



800B – E27 Task Lamp

Size : Dia.155mm. X H950mm.

Materials : Steel and PC

Lamp socket : 1 x E27

Voltage : 220

IP20

Unit price : 715 THB



Color





810B – E27 2 in 1 Task Lamp

Size : Base : Dia.150mm. X H600mm.

Materials : Steel and PC

Lamp socket : 1 x E27

Voltage : 220

IP20

Unit price : 660 THB

Color





711T-S – E27 Task Lamp

Size : Base : Dia.140mm. X H390mm.

Materials : Steel and PC

Lamp socket : 1 x E27

Voltage : 220

IP20

Unit price : 415 THB



Color





711T-C – E27 Task Lamp

Size : Dia.115mm. X H380mm.

Materials : Steel and PC

Lamp socket : 1 x E27

Voltage : 220

IP20

Unit price : 415 THB

Color



**203 – E27 Task Lamp**

Size : Base : Dia.140mm. X H320mm.

Materials : Steel and PC

Lamp socket : 1 x E27

Voltage : 220

IP20

Unit price : 290 THB

**Color**



DN-SE20-WH

DN-SE20-BK

Size : Base : Dia.140mm. X L200mm.

Materials : Steel and PC

Lamp socket : 1 x E27

Voltage : 220

Unit price : 230 THB



DN-SE30-WH

DN-SE30-BK

Size : Base : Dia.140mm. X L300mm.

Materials : Steel and PC

Lamp socket : 1 x E27

Voltage : 220

Unit price : 260 THB



DN-TJ20-WH

DN-TJ20-BK

Size : Base : Dia.140mm. X L200mm.

Materials : Steel

Lamp socket : 1 x E27

Voltage : 220

Unit price : 275 THB



DN-TJ30-WH

DN-TJ30-BK

Size : Base : Dia.140mm. X L300mm.

Materials : Steel

Lamp socket : 1 x E27

Voltage : 220

Unit price : 290 THB



DNER
LIGHTING & LED

VINTAGE LIGHT BULB



6w Dim

LED DN3B002 หริ้แสงได้ แก้วสีชา

Socket type : **E14**

Voltage : 220V

Watt : 6W

Light color : Warmwhite

Material : Clear glass

Unit price : 190 THB

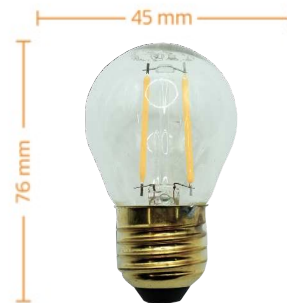

3w E27

LED DN3B003 G45

Socket type : **E27**

Voltage : 220V

Watt : 3W

Light color : Warmwhite

Material : Clear glass

Unit price : 95 THB



3w E14

LED DN3B004 G45

Socket type : **E14**

Voltage : 220V

Watt : 3W

Light color : Warmwhite

Material : Clear glass

Unit price : 100 THB

LED VINTAGE



4w

LED DN3B005 A60

Socket type : E27

Voltage : 220V

Watt : 4W

Light color : Warmwhite

Material : Clear glass

Unit price : 200 THB



6w

Dim

LED DN-ST644D ST64 หลี่แสงได้ แก้วสีชา

Socket type : E27

Voltage : 220V

Watt : 6W

Light color : Warmwhite

Material : Amber glass

Unit price : 290 THB

LED VINTAGE



4w

LED DN3B006 ST64 ใส่นิว

Socket type : E27

Voltage : 220V

Watt : 4W

Light color : Warmwhite

Material : Clear glass

Unit price : 215 THB



6w

LED DN3B007 ST64 ใส่น้ำ แก้วสีชา

Socket type : E27

Voltage : 220V

Watt : 6W

Light color : Warmwhite

Material : Amber glass

Unit price : 140 THB

LED VINTAGE



6w

LED DN3B008 G95 ใส่น้ัน แก้วสีชา

Socket type : E27

Voltage : 220V

Watt :6W

Light color : Warmwhite

Material : Amber glass

Unit price : 195 THB



6w Dim

LED DN3B010 G125 หรี่แสงได้ แก้วสีชา

Socket type : E27

Voltage : 220V

Watt : 6W

Light color : Warmwhite

Material : Amber glass

Unit price : 360 THB



6w Dim

LED DN-GA95D G95 ใส่น้ยา แก้วสีชา หรี่แสงได้

Socket type : E27

Voltage : 220V

Watt : 6W

Light color : Warmwhite

Material : Amber glass

Unit price : 315 THB



4w

LED DN-GA125D G125 ใส่น้ยา

Socket type : E27

Voltage : 220V

Watt : 4W

Light color : Warmwhite

Material : Amber glass

Unit price : 260 THB

LED VINTAGE



4w

LED DN3B022 G95 แก้วสีขาวนม

Socket type : E27

Voltage : 220V

Watt : 4W

Light color : Warmwhite

Material : Milky glass

Unit price : 215 THB



6w

LED DN3B023 G95 ใส่นิว แก้วสีชา

Socket type : E27

Voltage : 220V

Watt : 6W

Light color : Warmwhite

Material : Amber glass

Unit price : 230 THB



LED DN-T4504 T45 แก้วสีชา

Socket type : E27

Voltage : 220V

Watt : 6W

Light color : Warmwhite

Material : Amber glass

Unit price : 145 THB



LED DN3B009 G125 ใส่น้ำ แก้วสีชา

Socket type : E27

Voltage : 220V

Watt : 6W

Light color : Warmwhite

Material : Amber glass

Unit price : 186 THB

LED VINTAGE

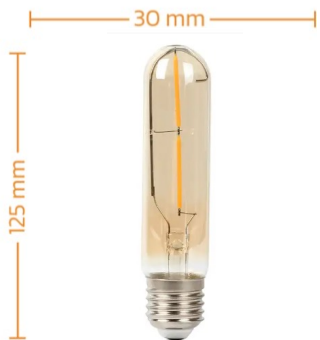

6w

LED DN3B012 T125 แก้วสีชา

Socket type : E27

Voltage : 220V

Watt : 6W

Light color : Warmwhite

Material : Amber glass

Unit price : 145 THB



6w

LED DN3B013 T225 แก้วสีชา

Socket type : E27

Voltage : 220V

Watt : 6W

Light color : Warmwhite

Material : Amber glass

Unit price : 230 THB



9w

LED DN3B014 T300 แก้วสีชา

Socket type : E27

Voltage : 220V

Watt : 9W

Light color : Warmwhite

Material : Amber glass

Unit price : 245 THB



40w Dim

DN3B017 ST64 หลอดไส้ หรือแสงได้

Socket type : E27

Voltage : 220V

Watt : 40W

Light color : Warmwhite

Material : Amber glass

Unit price : 130 THB



40w Dim

DN3B018 G95 หลอดไส้ หรือแสงได้

Socket type : E27

Voltage : 220V

Watt : 40W

Light color : Warmwhite

Material : Amber glass

Unit price : 145 THB



40w Dim

DN3B019 T30 หลอดไส้ หรือแสงได้

Socket type : E27

Voltage : 220V

Watt : 40W

Light color : Warmwhite

Material : Amber glass

Unit price : 175 THB



40w Dim

DN3B020 G125 หลอดไส้ หรือแสงได้

Socket type : E27

Voltage : 220V

Watt : 40W

Light color : Warmwhite

Material : Amber glass

Unit price : 160 THB



LED
LIGHT BULB

LED MR16

5w

LED DN3A007/WW

Socket type : **MR16 (GU5.3)**

Voltage : **220V**

Watt : 5W

Lumens : 450 lm

Beam angle : 36 degree

CRI : 80

Light color : **Warmwhite**

Material : PC

Unit price : 110 THB



High quality
COB chip

5w

LED DN3A007/NL

Socket type : **MR16 (GU5.3)**

Voltage : **220V**

Watt : 5W

Lumens : 450 lm

Beam angle : 36 degree

CRI : 80

Light color : **Cool Natural light**

Material : PC

Unit price : 110 THB



5w

LED DN3A007/WH

Socket type : **MR16 (GU5.3)**

Voltage : **220V**

Watt : 5W

Lumens : 450 lm

Beam angle : 36 degree

CRI : 80

Light color : **White Daylight**

Material : PC

Unit price : 110 THB



MR16 light fitted with GU5.3 socket

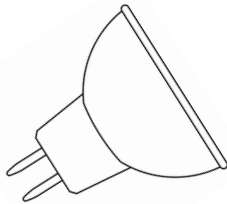

LED MR16

7w

LED DN3A011/WW

Socket type : **MR16 (GU5.3)**

Voltage : **220V**

Watt : 7W

Lumens : 840 lm

Beam angle : 36 degree

CRI : 80

Light color : **Warmwhite**

Material : PC

Unit price : 130 THB



7w

LED DN3A011/NL

Socket type : **MR16 (GU5.3)**

Voltage : **220V**

Watt : 7W

Lumens : 840 lm

Beam angle : 36 degree

CRI : 80

Light color : **Cool Natural light**

Material : PC

Unit price : 130 THB



7w

LED DN3A011/WH

Socket type : **MR16 (GU5.3)**

Voltage : **220V**

Watt : 7W

Lumens : 840 lm

Beam angle : 36 degree

CRI : 80

Light color : **White Daylight**

Material : PC

Unit price : 130 THB



High quality
COB chip



Warm white

Natural light

White

LED MR16

7w Dim



LED DN3A013/WW
DIMMABLE*
Socket type : **MR16 (GU5.3)**
Voltage : **220V**
Watt : 7W
Lumens : 840 lm
Beam angle : 36 degree
CRI : 80
Light color : **Warmwhite**
Material : PC
Unit price : 215 THB



7w Dim



LED DN3A013/NL
DIMMABLE*
Socket type : **MR16 (GU5.3)**
Voltage : **220V**
Watt : 7W
Lumens : 840 lm
Beam angle : 36 degree
CRI : 80
Light color : **Cool Natural light**
Material : PC
Unit price : 215 THB



7w Dim



LED DN3A013/WH
DIMMABLE*
Socket type : **MR16 (GU5.3)**
Voltage : **220V**
Watt : 7W
Lumens : 840 lm
Beam angle : 36 degree
CRI : 80
Light color : **White Daylight**
Material : PC
Unit price : 215 THB



High quality
COB chip



LED MR16

7w

12v

LED DN3A015/WW

Socket type : MR16 (GU5.3)

Voltage : 12V

Watt : 7W

Lumens : 840 lm

Beam angle : 36 degree

CRI : 80

Light color : Warmwhite

Material : PC

Unit price : 140 THB



7w

12v

LED DN3A015/NL

Socket type : MR16 (GU5.3)

Voltage : 12V

Watt : 7W

Lumens : 840 lm

Beam angle : 36 degree

CRI : 80

Light color : Cool Natural light

Material : PC

Price : 140 THB



7w

12v

LED DN3A015/WH

Socket type : MR16 (GU5.3)

Voltage : 12V

Watt : 7W

Lumens : 840 lm

Beam angle : 36 degree

CRI : 80

Light color : White Daylight

Material : PC

Unit price : 140 THB



High quality
COB chip



LED GU10

7w

LED DN3A012/WW

Socket type : **GU10**

Voltage : **220V**

Watt : 7W

Lumens : 840 lm

Beam angle : 36 degree

CRI : 80

Light color : **Warmwhite**

Material : PC

Unit price : 190 THB



7w

LED DN3A012/NL

Socket type : **GU10**

Voltage : **220V**

Watt : 7W

Lumens : 840 lm

Beam angle : 36 degree

CRI : 80

Light color : **Cool Natural light**

Material : PC

Unit price : 190 THB



7w

LED DN3A012/WH

Socket type : **GU10**

Voltage : **220V**

Watt : 7W

Lumens : 840 lm

Beam angle : 36 degree

CRI : 80

Light color : **White Daylight**

Material : PC

Unit price : 190 THB



High quality
COB chip

GU10 light fitted with GU10 socket

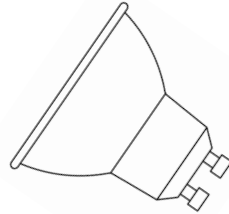

7w Dim



LED DN3A014/WW
DIMMABLE*

Socket type : **GU10**
Voltage : **220V**
Watt : 7W
Lumens : 840 lm
Beam angle : 36 degree
CRI : 80
Light color : **Warmwhite**
Material : PC
Unit price : 275 THB



7w Dim



LED DN3A014/NL
DIMMABLE*

Socket type : **GU10**
Voltage : **220V**
Watt : 7W
Lumens : 840 lm
Beam angle : 36 degree
CRI : 80
Light color : **Cool Natural light**
Material : PC
Unit price : 275 THB



7w Dim



LED DN3A014/WH
DIMMABLE*

Socket type : **GU10**
Voltage : **220V**
Watt : 7W
Lumens : 840 lm
Beam angle : 36 degree
CRI : 80
Light color : **White Daylight**
Material : PC
Unit price : 275 THB



High quality
COB chip



LED MR16 & GU10 : *ECO Series*



DNMR167WW

ECO Series

Socket type : **MR16** (GU5.3)

Voltage : **220V**

Watt : 7W

Lumens : 700 lm

Beam angle : 38 degree

CRI : 80

Light color : **Warmwhite**

Material : PC

Unit price : 115 THB



DNMR167NW

ECO Series

Socket type : **MR16** (GU5.3)

Voltage : **220V**

Watt : 7W

Lumens : 700 lm

Beam angle : 38 degree

CRI : 80

Light color : **Cool Natural light**

Material : PC

Unit price : 115 THB



DNMR167WH

ECO Series

Socket type : **MR16** (GU5.3)

Voltage : **220V**

Watt : 7W

Lumens : 700 lm

Beam angle : 38 degree

CRI : 80

Light color : **White Daylight**

Material : PC

Unit price : 115 THB



DNGC107WW

ECO Series

Socket type : **GU10**

Voltage : **220V**

Watt : 7W

Lumens : 700 lm

Beam angle : 38 degree

CRI : 80

Light color : **Warmwhite**

Material : PC

Unit price : 130 THB



DNGC107NW

ECO Series

Socket type : **GU10**

Voltage : **220V**

Watt : 7W

Lumens : 700 lm

Beam angle : 38 degree

CRI : 80

Light color : **Cool Natural light**

Material : PC

Unit price : 130 THB



DNGC107WH

ECO Series

Socket type : **GU10**

Voltage : **220V**

Watt : 7W

Lumens : 700 lm

Beam angle : 38 degree

CRI : 80

Light color : **White Daylight**

Material : PC

Unit price : 130 THB



7w

LED DN3A051/WW

Socket type : E27 (MR16 cup)

Voltage : 220V

Watt : 7W

Lumens : 840 lm

Beam angle : 36 degree

CRI : 80

Light color : Warmwhite

Material : PC

Unit price : 130 THB



7w

LED DN3A051/NL

Socket type : E27 (MR16 cup)

Voltage : 220V

Watt : 7W

Lumens : 840 lm

Beam angle : 36 degree

CRI : 80

Light color : Cool Natural light

Material : PC

Unit price : 130 THB



7w

LED DN3A051/WH

Socket type : E27 (MR16 cup)

Voltage : 220V

Watt : 7W

Lumens : 840 lm

Beam angle : 36 degree

CRI : 80

Light color : White Daylight

Material : PC

Unit price : 130 THB





LED DN3A016/WW

Socket type : E27 PAR20

Voltage : 220V

Watt : 10W

Lumens : 1050 lm

Beam angle : 24 degree

CRI : 80

Light color : Warmwhite

Material : PC

Unit price : 345 THB



LED DN3A016/NL

Socket type : E27 PAR20

Voltage : 220V

Watt : 10W

Lumens : 1050 lm

Beam angle : 24 degree

CRI : 80

Light color : Cool Natural light

Material : PC

Unit price : 345 THB



Warm white

Natural light

White



LED DN3A051/WH

Socket type : E27 PAR20

Voltage : 220V

Watt : 10W

Lumens : 1050 lm

Beam angle : 24 degree

CRI : 80

Light color : White Daylight

Material : PC

Unit price : 345 THB





12w

DNMJF012 LED Module

Voltage : 220V

Watt : 12W

Lumens : 1200 lm

Beam angle : 38 degree

CRI : 80

Light color : Warmwhite /
Natural light 4000K / White Daylight

Unit price : 575 THB

CODE

DNMJF012WW : Warmwhite

DNMJF012NW : Cool Natural light

DNMJF012WH : White Daylight



12w DIM

DNMJF012 LED Module + DIMMABLE

Voltage : 220V

Watt : 12W

Lumens : 1200 lm

Beam angle : 38 degree

CRI : 80

Light color : Warmwhite /
Natural light 4000K / White Daylight

Unit price : 715 THB

CODE

DNMJF012WW-DIM : Warmwhite

DNMJF012NW-DIM : Cool Natural light

DNMJF012WH-DIM : White Daylight

LED E27 PAR 30



20w

LED DN3A018/WW

Socket type : E27 PAR30 COB

Voltage : 220V

Watt : 20W

Lumens : 2000 lm

Beam angle : 24 degree

CRI : 80

Light color : Warm white

Material : PC

Unit price : 475 THB



20w

LED DN3A018/NL

Socket type : E27 PAR30 COB

Voltage : 220V

Watt : 20W

Lumens : 2000 lm

Beam angle : 24 degree

CRI : 80

Light color : Natural light

Material : PC

Unit price : 475 THB



20w

LED DN3A018/WH

Socket type : E27 PAR30 COB

Voltage : 220V

Watt : 20W

Lumens : 2000 lm

Beam angle : 24 degree

CRI : 80

Light color : White Daylight

Material : PC

Unit price : 475 THB



LED E27 PAR 30



35w

LED DN3A019/WW

Socket type : E27 PAR30 SMD

Voltage : 220V

Watt : 35W

Lumens : 3500 lm

Beam angle : 24 degree

CRI : 80

Light color : Warm white

Material : PC

Unit price : 545 THB



35w

LED DN3A019/NL

Socket type : E27 PAR30 SMD

Voltage : 220V

Watt : 35W

Lumens : 3500 lm

Beam angle : 24 degree

CRI : 80

Light color : Natural light

Material : PC

Unit price : 545 THB



35w

LED DN3A019/WH

Socket type : E27 PAR30 SMD

Voltage : 220V

Watt : 35W

Lumens : 3500 lm

Beam angle : 24 degree

CRI : 80

Light color : White Daylight

Material : PC

Unit price : 545 THB



LED E27 PAR 30



30w

LED DN3A020/WW

Socket type : E27 PAR30 SMD

Voltage : 220V

Watt : 30W

Lumens : 3000 lm

Beam angle : 24 degree

CRI : 80

Light color : Warm white

Material : PC

Unit price : 430 THB



30w

LED DN3A020/NL

Socket type : E27 PAR30 SMD

Voltage : 220V

Watt : 30W

Lumens : 3000 lm

Beam angle : 24 degree

CRI : 80

Light color : Natural light

Material : PC

Unit price : 430 THB



30w

LED DN3A020/WH

Socket type : E27 PAR30 SMD

Voltage : 220V

Watt : 30W

Lumens : 3000 lm

Beam angle : 24 degree

CRI : 80

Light color : White Daylight

Material : PC

Unit price : 430 THB



LED E27 PAR 38



12w

LED DN3A021/WH



Socket type : E27 PAR38 SMD PC

Voltage : 220V

Watt : 12W

Lumens : 1200 lm

Beam angle : 24 degree

CRI : 80

Light color : White Daylight

Material : PC

Unit price : 245 THB



16w

LED DN3A022/WW



Socket type : E27 PAR38 SMD

Voltage : 220V

Watt : 16W

Lumens : 1500 lm

Beam angle : 30 degree

CRI : 80

Light color : Warm White

Material : Glass

Unit price : 500 THB



18w

LED DN3A023/WH

Socket type : E27 PAR38 SMD PC

Voltage : 220V

Watt : 18W

Lumens : 1800 lm

Beam angle : 30 degree

CRI : 80

Light color : White Daylight

Material : PC

Unit price : 500 THB

LED AR111/GU10



15w

LED DN3A024/WW

Socket type : **AR111**
Voltage : **175-264V**
Watt : 15W
Lumens : 1500 lm
Beam angle : 38 degree
CRI : 80
Light color : **Warm white**
Unit price : 575 THB



15w

LED DN3A024/NL

Socket type : **AR111**
Voltage : **175-264V**
Watt : 15W
Lumens : 1500 lm
Beam angle : 38 degree
CRI : 80
Light color : **Natural light**
Unit price : 575 THB



15w

LED DNARGU111/WW

Socket type : **GU10**
Voltage : **175-264V**
Watt : 15W
Lumens : 1500 lm
Beam angle : 38 degree
CRI : 80
Light color : **Warm white**
Unit price : 575 THB



15w

LED DNARGU111/NL

Socket type : **GU10**
Voltage : **175-264V**
Watt : 15W
Lumens : 1500 lm
Beam angle : 38 degree
CRI : 80
Light color : **Natural light**
Unit price : 575 THB



LED BULB E27



3w

LED DN3A044

Socket type : **E27 Pingpong Clear**

Voltage : **220V**

Watt : 3W

Light color : **Warm white**

Material : Clear PC

Unit price : 30 THB



3w

LED DN3A045

Socket type : **E27 Pingpong Milky**

Voltage : **220V**

Watt : 3W

Light color : **Warm white**

Material : Milky PC

Unit price: 44 THB



LED BULB E27



3w

LED DN3A026

Socket type : E27 Pingpong

Voltage : 220V

Watt : 3W

Light color : RED / GREEN / BLUE / YELLOW / PINK
ORANGE / WHITE / WARMWHITE / RGB

Material : Clear PC

Unit price : 30 THB



3w

LED DNS1403

Socket type : E27

Voltage : 220V

Watt : 3W

Light color : Warm white / RED / GREEN /
YELLOW / PINK / BLUE

Material : PC

Unit price : 45 THB

LED DNS1403 RGB เปลี่ยนสีได้

Watt : 3W

Unit price : 58 THB



2w

LED S14LSWW (ฟิลาเมนต์ดาวตก)

Socket type : E27

Voltage : 220V

Watt : 2W

Light color : Warm white

Material : PC

Unit price : 45 THB

LED BULB E27



3w

LED DN3A027/WW

Socket type : E27 Bulb

Voltage : 220V

Watt : 3W

Light color : Warm white

Material : PC

Unit price : 59 THB



3w

LED DN3A027/WH

Socket type : E27 Bulb

Voltage : 220V

Watt : 3W

Light color : White Daylight

Material : PC

Unit price : 59 THB



40 mm



100 mm

5w

LED DN-3705/WW

Socket type : **E14**

Voltage : **220V**

Watt : 5W

Light color : **Warm white**

Material : PC

Unit price : 100 THB



40 mm



100 mm

5w

LED DN-3705/WH

Socket type : **E14**

Voltage : **220V**

Watt : 5W

Light color : **White Daylight**

Material : PC

Unit price : 100 THB



35 mm

135 mm



3w

LED DN3A037/WW

Socket type : **E14**

Voltage : **220V**

Watt : 3W

Light color : **Warm white**

Material : Clear PC

Unit price : 87 THB



35 mm

135 mm



3w

LED DN3A037/WH

Socket type : **E14**

Voltage : **220V**

Watt : 3W

Light color : **White Daylight**

Material : Clear PC

Unit price : 87 THB



LED E14 CRYSTAL



5w

LED DN3A038/WW

Socket type : **E14**
Voltage : **220V**
Watt : 5W
Light color : **Warm white**
Material : Crystal clear PC
Unit price : 180 THB



5w

LED DN3A038/NL

Socket type : **E14**
Voltage : **220V**
Watt : 5W
Light color : **Natural light**
Material : Crystal clear PC
Unit price : 180 THB



LED G4



3w 12v

LED DN3A040-1

Socket type : **G4**

Voltage : **12V**

Watt : 3W

Light color : **Warm white**

Material : PC

Unit price : 95 THB



3w

LED DN3A040

Socket type : **G4**

Voltage : **220V**

Watt : 3W

Light color : **Warm white**

Material : PC

Unit price : 95 THB



9w

LED DN3A042

Socket type : **G4**

Voltage : **220V**

Watt : 9W

Light color : **Warm white**

Material : PC

Unit price : 190 THB



3w

LED DNG4505

Socket type : **G4 COB**

Voltage : **220V**

Watt : 3W

Light color : **Warm white**
White

Material : Silicone

Unit price : 160 THB



3w 12v

LED DNG4125WW / DNG4125WH

Socket type : **G4 COB**

Voltage : **12V**

Watt : 3W

Light color : **Warm white**
White

Material : Silicone

Unit price : 160 THB



LED E14 - G9



5w



LED DN-E-1405

Socket type : **E14**

Voltage : **220V**

Watt : 5W

Light color : **Warm white**
White Daylight

Material : PC

Unit price : 145 THB



14 mm



50 mm

3w



LED DN3A041

Socket type : **G9**

Voltage : **220V**

Watt : 3W

Light color : **Warm white**

Material : PC

Unit price : 115 THB



14 mm



50 mm

3w



LED DN3A052

Socket type : **G9**

Voltage : **220V**

Watt : 3W

Light color : **White Daylight**

Material : PC

Unit price : 115 THB



14 mm



60 mm

9w



LED DN3A043

Socket type : **G9**

Voltage : **220V**

Watt : 9W

Light color : **Warm white**

Material : PC

Unit price : 200 THB



14 mm



60 mm

9w

Dim



LED DN3A050

DIMMABLE*

Socket type : **G9**

Voltage : **220V**

Watt : 9W

Light color : **White Daylight**

Material : PC

Unit price : 230 THB



14 mm



60 mm

9w

Dim



LED DN3A051

DIMMABLE*

Socket type : **G9**

Voltage : **220V**

Watt : 9W

Light color : **Warm white**

Material : PC

Unit price : 230 THB





DN3A002WW

DN3A002WH

Socket type : **GU5.3**

Voltage : **220V**

Watt : 3W

Light color : **Warm white**
White Daylight

Material : Glass

Unit price : 86 THB



DNMR1123WW

DNMR1123WH

Socket type : **GU5.3**

Voltage : **12V**

Watt : 3W

Light color : **Warm white**
White Daylight

Material : Glass

Unit price : 115 THB



LED E27 CONTROL



12w

LED DN3A046

Control color

Socket type : E27

Voltage : 220V

Watt : 12W

Light color : RGB+White

Material : PC

Unit price : 375 THB



12w

LED DN3A047

Control color

Socket type : E27

Voltage : 220V

Watt : 12W

Light color : RGB+Warmwhite

Material : PC

Unit price : 375 THB



9w

LED DN3A048

Control color

Socket type : E27

Voltage : 220V

Watt : 9W

Light color : Warmwhite + White

Material : PC

Unit price : 545 THB



12w

LED DN3A049

Control color

Socket type : E27

Voltage : 220V

Watt : 12W

Light color : Warmwhite + White

Material : PC

Unit price : 580 THB





LANDSCAPE LIGHTING



WL2014B



Down wall lamp

Size : Dia.90 x H200mm.

Aluminum and glass

Lamp : 1 x E27

Voltage : 220Vac

IP Rating : IP54

Unit price : 775 THB



WL2015B



Down wall lamp

Size : Dia.108 x H200mm.

Aluminum and glass

Lamp : 1 x E27

Voltage : 220Vac

IP Rating : IP54

Unit price : 800 THB

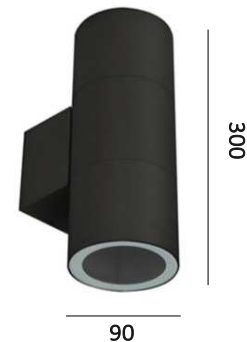

WL2016B



Up-Down wall lamp

Size : Dia.90 x H300mm.

Aluminum and glass

Lamp : 2 x E27

Voltage : 220Vac

IP Rating : IP54

Unit price : 930 THB



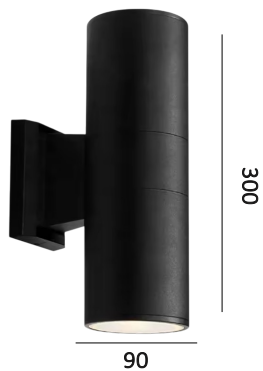

WL2010B



UP - Down wall lamp

Size : Dia.90 x H300mm.

Aluminum and glass

Lamp : 2 x E27

Voltage : 220Vac

IP Rating : IP54

Unit price : 860 THB



WL2012B



UP - Down wall lamp

Size : Dia.110 x H300mm.

Aluminum and glass

Lamp : 2 x E27

Voltage : 220Vac

IP Rating : IP54

Unit price : 945 THB

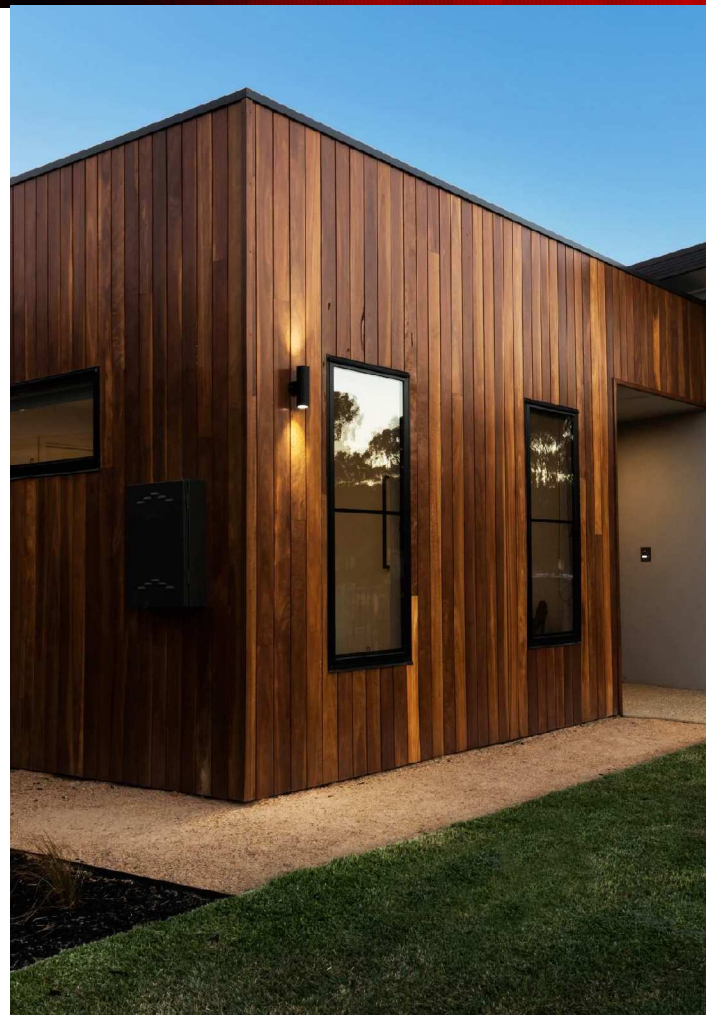

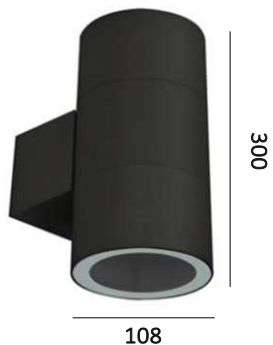

WL2017B



Up-Down wall lamp

Size : Dia.108 x H300mm.

Aluminum and glass

Lamp : 2 x E27

Voltage : 220Vac

IP Rating : IP54

Unit price : 975 THB

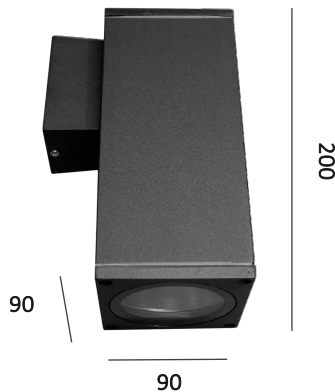

WL2018B



Down wall lamp

Size : W90 x L90 x H200mm.

Aluminum and glass

Lamp : 1 x E27

Voltage : 220Vac

IP Rating : IP54

Unit price : 800 THB

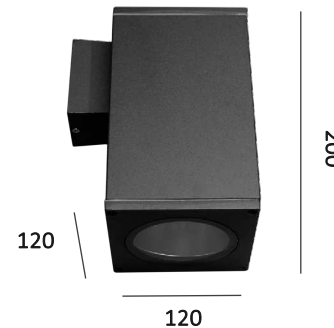

WL2019B



Down wall lamp

Size : W120 x L120 x H200mm.

Aluminum and glass

Lamp : 1 x E27

Voltage : 220Vac

IP Rating : IP54

Unit price : 1215 THB



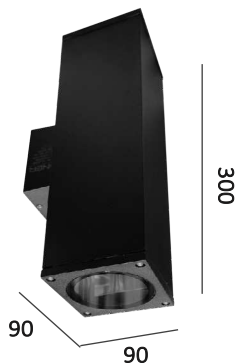

WL2020B

Up-Down wall lamp

Size : W90 x L90 x H300mm.

Aluminum and glass

Lamp : 2 x E27

Voltage : 220Vac

IP Rating : IP54

Unit price : 1200 THB



WL2021B

Up-Down wall lamp

Size : W120 x L120 x H300mm.

Aluminum and glass

Lamp : 2 x E27

Voltage : 220Vac

IP Rating : IP54

Unit price : 1430 THB



DN-WL1801

Up-Down wall lamp

Size : Dia.108 x H300mm.

Aluminum and frosted glass

Lamp : 2 x E27

Voltage : 220Vac

IP Rating : IP54

Unit price : 715 THB





DNWMS714BK

Up-Down wall lamp

Size : W90 x L150 x H300mm.

Aluminum and PC

Lamp : 2 x E27

Voltage : 220Vac

IP Rating : IP54

Unit price : 1,000 THB

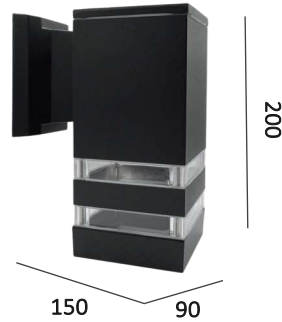

DNWMS718BK

Down wall lamp

Size : W90 x L150 x H200mm.

Aluminum and PC

Lamp : 1 x E27

Voltage : 220Vac

IP Rating : IP54

Unit price : 775 THB



JMPTWGU10

Up-Down wall lamp

Size : Dia.90 x H200mm.

Aluminum and glass

Lamp : 2 x GU10

Voltage : 220Vac

IP Rating : IP54

Unit price : 1,080 THB





DN-B20661

Up-Down wall lamp

Size : Dia.108 x H340mm.

Aluminum and glass

Lamp : 2 x E27

Voltage : 220Vac

IP Rating : IP54

Unit price : 860 THB



DN-AK301

wall lamp

Size : Dia.108 x H220mm.

Aluminum and glass

Lamp : 1 x E27

Voltage : 220Vac

IP Rating : IP54

Unit price : 715 THB

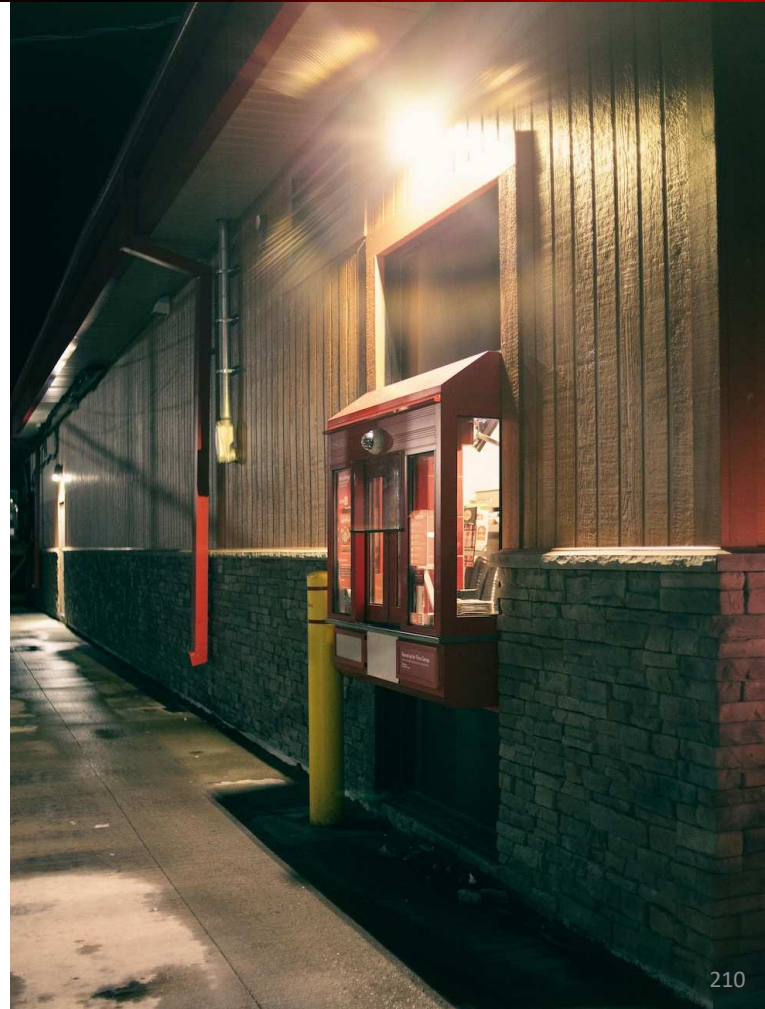



VEN2701

Glass wall lamp

Size : Dia.130 x H515mm.

Aluminum dark brown and clear glass

Lamp : 1 x E27

Voltage : 220Vac

IP Rating : IP44

Unit price : 2900 THB



YF-9901

Glass wall lamp

Size : W300 x H600mm.

Aluminum and glass

Lamp : 1 x E27

Voltage : 220Vac

IP Rating : IP44

Unit price : 2720 THB

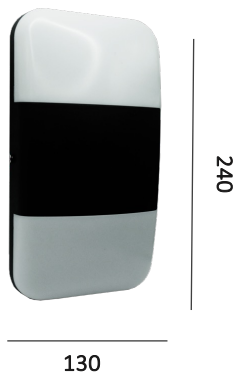

C3138

Up-Down wall lamp

Size : W47 x L130 x H240mm.
 Aluminum and PC
 Lamp : LED 12W Warm white
 Voltage : 220Vac
 IP Rating : IP54
 Unit price : 1130 THB

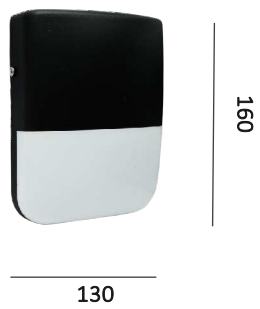

C3137

Down wall lamp

Size : W47 x L130 x H160mm.
 Aluminum and PC
 Lamp : LED 6W Warm white
 Voltage : 220Vac
 IP Rating : IP54
 Unit price : 875 THB



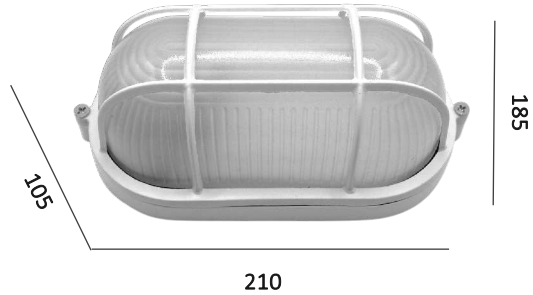

DN4A055WH

Wall lamp

Size : W105 x L210 x H185mm.

Aluminum and PC

Lamp : 1 x E27

Voltage : 220Vac

IP Rating : IP54

Unit price : 360 THB



DN4A055BK

Wall lamp

Size : W105 x L210 x H185mm.

Aluminum and PC

Lamp : 1 x E27

Voltage : 220Vac

IP Rating : IP54

Unit price : 360 THB



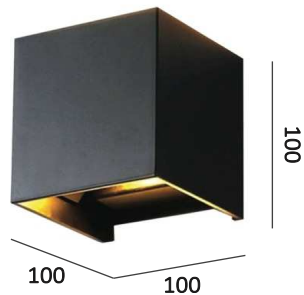

AB136-BK / AB136-WH
Up-Down LED wall lamp

Size : W100 x L100 x H100mm.
 Aluminum die-cast
 Lamp : 2 x LED COB 6W Warm white
 Voltage : 220Vac
 IP Rating : IP54
 Unit price : 845 THB

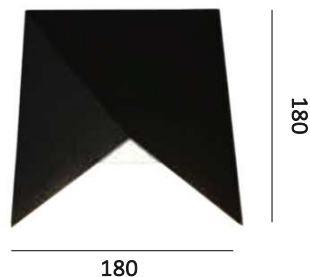

DT-7002
Down LED wall lamp

Size : W180 x L180 x H180mm.
 Aluminum die-cast
 Lamp : 1 x LED COB 7W Warm white
 Voltage : 220Vac
 IP Rating : IP54
 Unit price : 1430 THB







92



MB-40237

Down wall lamp

Size : W68 x L81 x H92mm.

Aluminum die-cast

Lamp : 1 x MR16

Voltage : 220Vac

IP Rating : IP54

Unit price : 575 THB



150



MB-40239

Up-Down wall lamp

Size : W68 x L92 x H150mm.

Aluminum die-cast

Lamp : 2 x MR16

Voltage : 220Vac

IP Rating : IP54

Unit price : 860 THB





92



MB-40238

Down wall lamp

Size : W68 x L81 x H92mm.
Aluminum die-cast
Lamp : 1 x MR16
Voltage : 220Vac
IP Rating : IP54
Unit price : 575 THB



150



MB-40240

Up-Down wall lamp

Size : W68 x L92 x H150mm.
Aluminum die-cast
Lamp : 2 x MR16
Voltage : 220Vac
IP Rating : IP54
Unit price : 860 THB





DN-9510WW

Size : Dia.95mm.
 Aluminum die-cast and glass
 Lamp : **LED COB 10W**
 Light Color : Warm white
 Beam angle : 45 Degree
 Voltage : 220Vac
 IP Rating : IP65
 Unit price : 820 THB



DN-9520CH

Size : Dia.95mm.
 Aluminum die-cast and glass with ground spike
 Lamp : **LED COB 10W**
 Light Color : Warm white
 Beam angle : 45 degree
 Voltage : 220Vac
 IP Rating : IP65
 Unit price : 890 THB



A1107

Ground Spike

Size : Dia.45 x H250mm.
 Aluminum die-cast and glass
 Lamp : **LED 3W**
 Light Color : White/Warm white/Pink/
 Red/Green/Blue/Yellow
 Voltage : 220Vac
 IP Rating : IP65
 Unit price : 400 THB

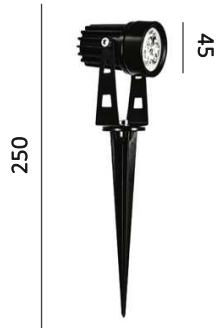

A1106-1

Ground Surfaced

Size : Dia.80 x H115mm.
 Aluminum die-cast and glass
 Lamp : **LED 5W**
 Light Color : Warm white / RGB
 Voltage : 220Vac
 IP Rating : IP65
 Unit price : 450 / 630 THB ไม่รวมขาปักดิน
 : ขาปักดิน 65 THB

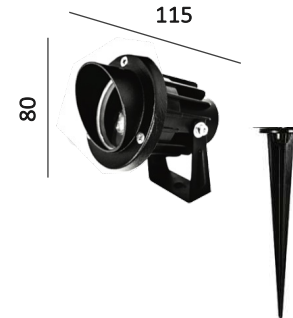



DN-A1001-1

Size : Dia.100 x H150mm.
Aluminum die-cast and glass
Lamp : 1 x MR16
IP Rating : IP65
Unit price : 375 THB ราคาไม่รวมขาปักดิน
: ขาปักดิน 65 THB



DN18-604

Size : Dia.58 x H180mm.
Aluminum die-cast and glass
Lamp : 1 x MR16
IP Rating : IP65
Unit price : 1,075 THB

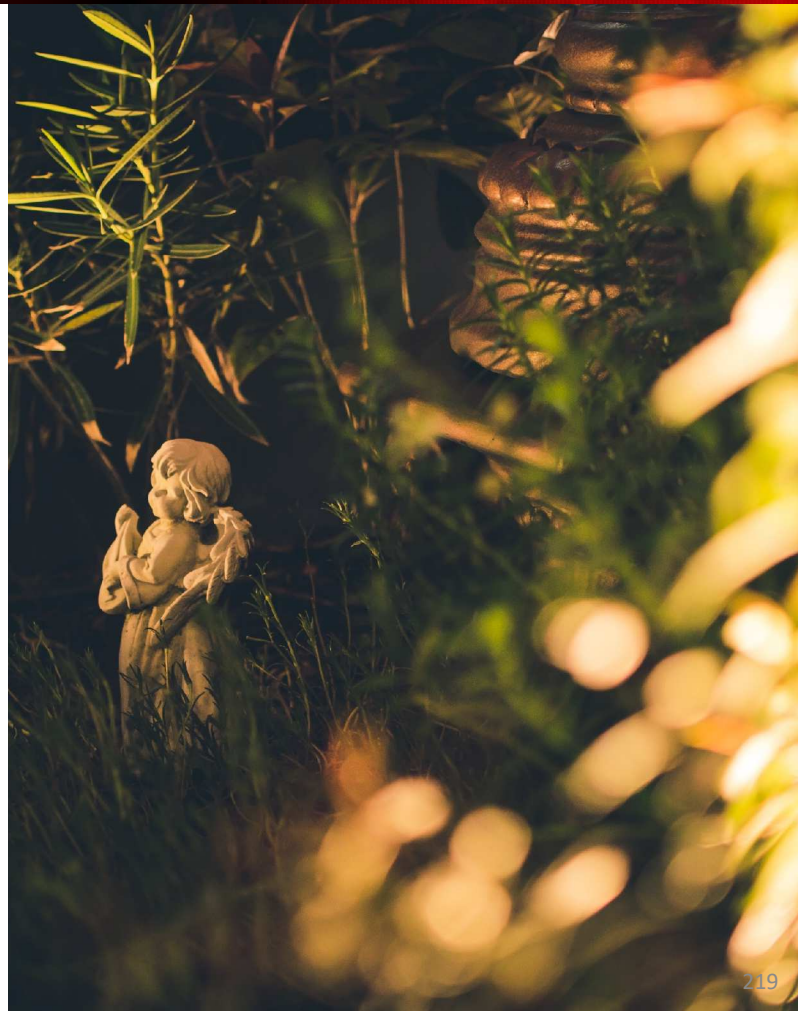



145



230

DN-SDD160S-WW

Under water lamp

Size : Dia.145 x H230mm.

Stainless 304 and glass

Lamp : LED High-Power 12W

Light Color : Warm white

Voltage : 12VDC/VAC – 24VDC/VAC

IP Rating : IP68

Unit price : 2500 THB

145



230

DN-SDD160S-RGB

Under water lamp

Size : Dia.145 x H230mm.

Stainless 304 and glass

Lamp : LED High-Power 12W

Light Color : RGB

Voltage : 12VAC

IP Rating : IP68

Unit price : 2575 THB





DN-8R08-WW

Under water lamp

Size : Dia.95 x H73mm.

Stainless 304 and glass

Lamp : **LED COB 10W**

Light Color : **Warm white**

Voltage : **12VDC/VAC**

IP Rating : IP65

Unit price : 575 THB



DN-8R08-RGB

Under water lamp

Size : Dia.95 x H73mm.

Stainless 304 and glass

Lamp : **LED COB 10W**

Light Color : **RGB**

Voltage : **12VDC** with Remote controller

IP Rating : IP65

Unit price : 645 THB



120



DN-S3016

Under water lamp

Size : Dia.82 x H120mm.
 Stainless 304 and glass
 Lamp : **1 x MR16**
 Voltage : 220Vac / 12Vac / 12Vdc
 IP Rating : IP68
 Unit price : 620 THB

100



120

UW6006

Under water lamp

Size : Dia.100 x H120mm.
 Stainless 304 and glass
 Lamp : **1 x MR16**
 IP Rating : IP68
 Unit price : 1,360 THB

120



DN-S023

Under water lamp

Size : Dia.82 x H120mm.
 Stainless 304 and glass
 Lamp : **LED 3W**
 Light Color : Warm white
 Voltage : 12Vdc / 24Vdc
 IP Rating : IP68
 Unit price : 775 THB

120



160

DN-SDD0612-WW

Under water lamp

Size : Dia.120 x H160mm.
 Stainless 304 and glass
 Lamp : **LED 6W**
 Color temp : Warm white
 Voltage : 12VDC/VAC – 24VDC/VAC
 Lens Angle : 25 degree
 IP Rating : IP68
 Unit price : 1,785 THB

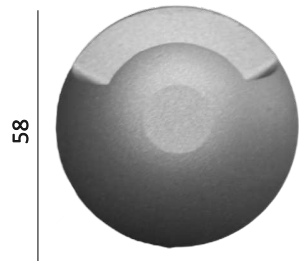

11326 – 1 way Inground light

Size : Dia.58 x H65mm.
Aluminum, PC Housing
Lamp : **LED 1.5W**
Light Color : Warm white
Voltage : 220VAC
IP Rating : IP65
Unit price : 2150 THB

1.5W



Housing size
Dia.62 x H95mm.

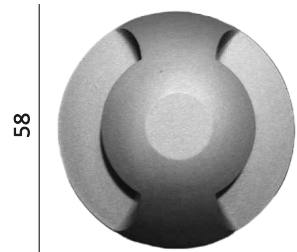

11328 – 2 ways Inground light

Size : Dia.58 x H65mm.
Aluminum, PC Housing
Lamp : **LED 1.5W**
Light Color : Warm white
Voltage : 220VAC
IP Rating : IP65
Unit price : 2150 THB

1.5W



Housing size
Dia.62 x H95mm.

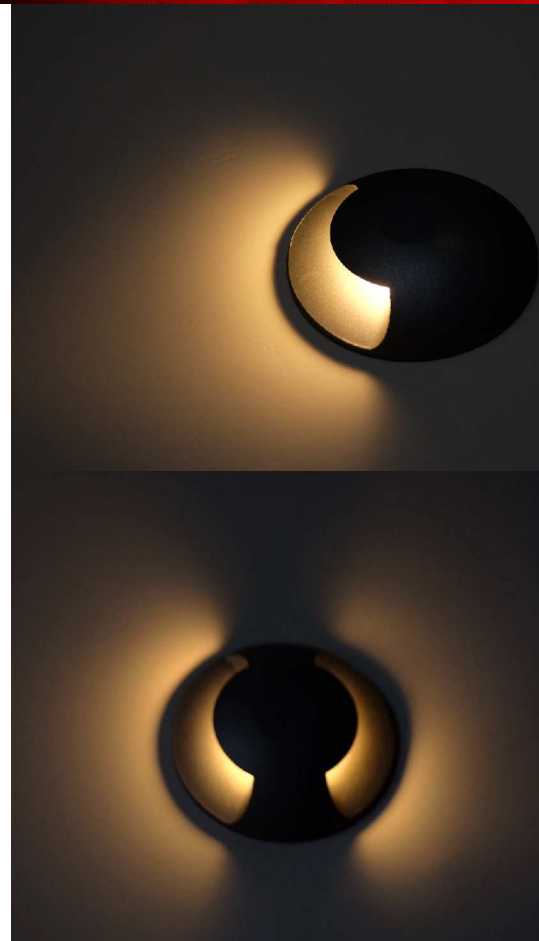

LANDSCAPE LIGHTING

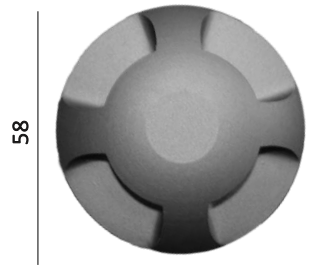

11332 – 4 ways

Inground light

Size : Dia.58 x H65mm.

Aluminum, PC Housing

Lamp : LED 1.5W

Light Color : Warm white

Voltage : 220VAC

IP Rating : IP65

Unit price : 2150 THB

1.5W



Housing size
Dia.62 x H95mm.

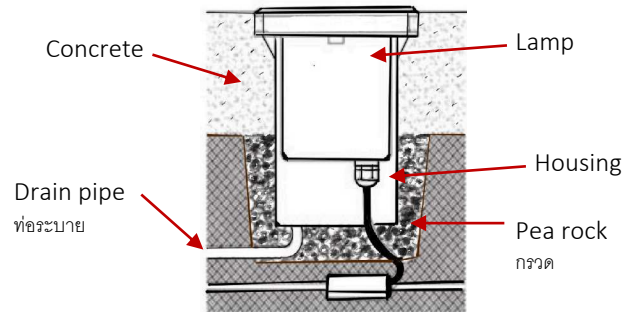



DN4075-WW

Inground Up light

Size : Dia.52 x H82mm.

Stainless 304 and glass, PC Housing

Lamp : **LED HIGH POWER 1W**

Light Color : Warm white

Beam angle : 30 degree

Voltage : 220VAC

IP Rating : IP65

Unit price : 645 THB



Cutting

Dia.45mm.



DN4075-12-WW

Inground Up light

Size : Dia.52 x H82mm.

Stainless 304 and glass, PC Housing

Lamp : **LED HIGH POWER 1W**

Light Color : Warm white

Beam angle : 30 degree

Voltage : 12VDC/VAC – 24VDC/VAC

IP Rating : IP65

Unit price : 645 THB



Cutting

Dia.45mm.



DN4076

Inground Up light

Size : Dia.65 x H78mm.

Stainless 304 and glass, PC Housing

Lamp : **LED COB 3W**

Light Color : Warm white

Beam angle : 30 degree

Voltage : 220VAC

IP Rating : IP65

Unit price : 715 THB



Cutting

Dia.62mm.



DN4077

Inground Up light

Size : Dia.65 x H78mm.

Stainless 304 and glass, PC Housing

Lamp : **LED COB 3W**

Light Color : Warm white

Beam angle : 30 degree

Voltage : 12VAC/VDC – 24VAC/VDC

IP Rating : IP65

Unit price : 715 THB



Cutting

Dia.62mm.





D1100

Inground Up light

Size : Dia.100 x H90mm.
 Stainless 304 and glass, PC Housing
 Lamp : LED COB 5W
 Light Color : Warm white
 Beam angle : 30 degree

Voltage : 220VAC

IP Rating : IP65
 Unit price : 800 THB



Cutting
 Dia.97mm.



D1112

Inground Up light

Size : Dia.100 x H90mm.
 Stainless 304 and glass, PC Housing
 Lamp : LED COB 5W
 Light Color : Warm white
 Beam angle : 30 degree

Voltage : 12VDC/VDC – 24VDC/VAC

IP Rating : IP65
 Unit price : 800 THB



Cutting
 Dia.97mm.

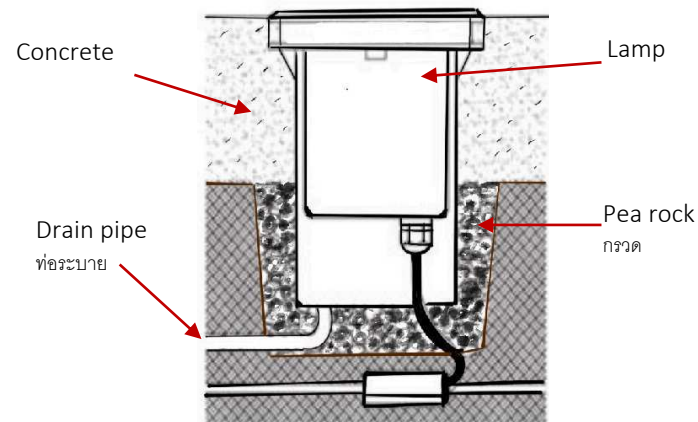



Dia.230 x H40mm.

Swimming Pool Lamp

DN-YYC2818

Size : Dia.230 x H40mm.

Stainless 304 and PC Housing

Lamp : **LED 18W**

Light Color : Warm white

Voltage : **24VDC/VAC**

IP Rating : IP68

Unit price : 4,000 THB



Dia.280 x H70mm.

Swimming Pool Lamp

DN-YYC2818-RGB

with Remote

Size : Dia.280 x H70mm.

Stainless 304 and PC Housing

Lamp : **LED 18W**

Light Color : RGB

Voltage : **24VAC**

IP Rating : IP68

Unit price : 4,290 THB

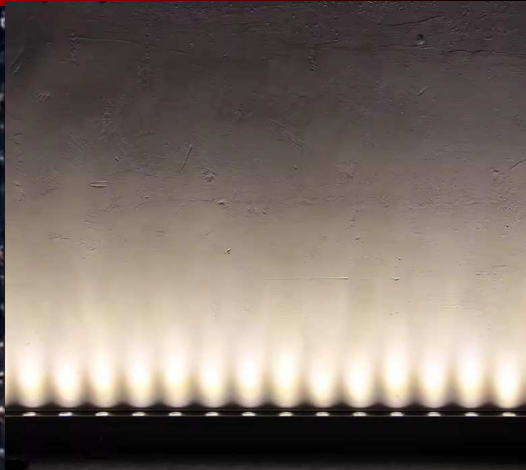

LED Wall Washer



24V 36D 36W

DN-WA3603

Size : W35 x H28 x L995mm.

Aluminum Housing

Lamp : LED 36W

Lens : 36 Degree

Light Color : **Warm white**

Voltage : **24VAC /VDC**

IP Rating : IP65

Unit price : 2450 THB



LED Wall Washer



24V 36D 36W

DN-WS036RGB

Size : W35 x H28 x L995mm.

Aluminum Housing

Lamp : LED 36W

Lens : 36 Degree

Light Color : **RGB**

Voltage : **24VAC /VDC**

IP Rating : IP65

Unit price : 4860 THB

85



K85-WH / K85-BK

LED Step light

Size : W50 x L85 x H85mm.

Aluminum die-cast

Lamp : **LED 3 x 1W**

Light Color : Warm white

Voltage : **220Vac**

IP Rating : IP44

Unit price : 575 THB

Cutting
67 x 67mm.



E5013S

LED Step light

Size : W55 x L110 x H45mm.

Aluminum die-cast with PC

Lamp : **LED 3W**

Light Color : White / Warm white

Voltage : **220Vac**

IP Rating : IP44

Unit price : 375 THB

Cutting
105 x 40mm.

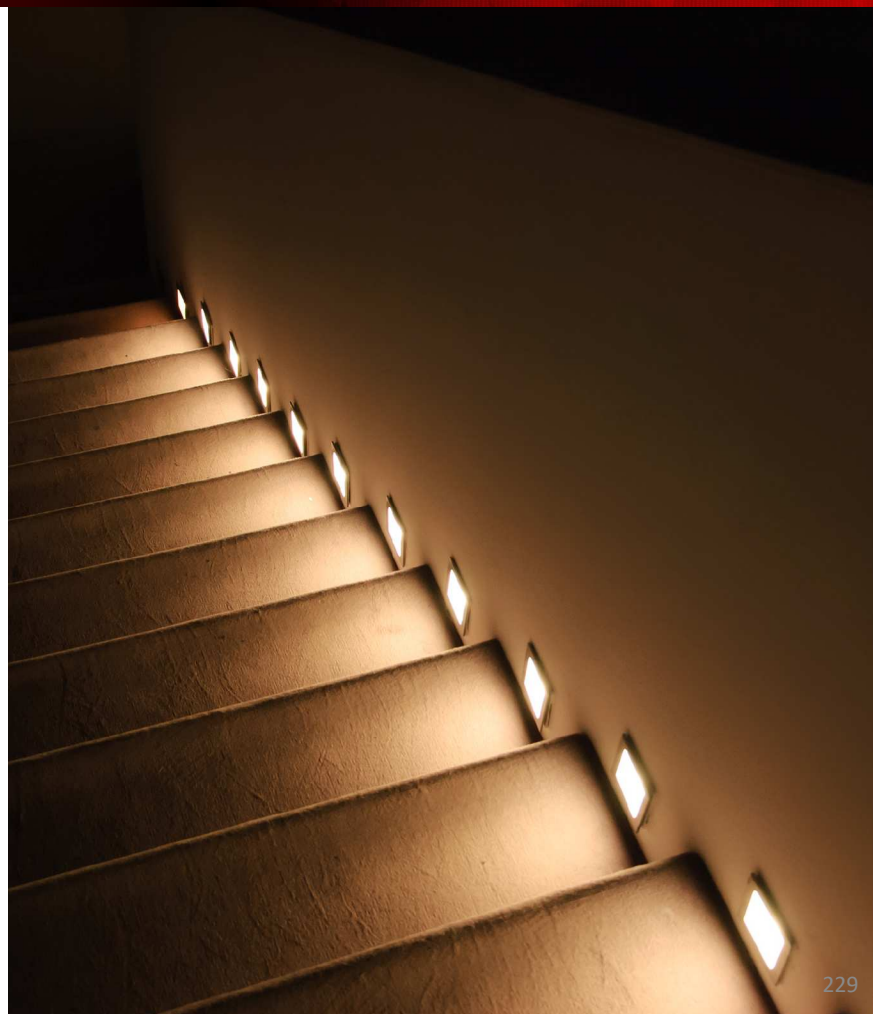



LS-4007

LED Bollard

Size : Dia.107 x H400mm.
 Aluminum die-cast
 Black powder coated
 Lamp : **LED COB 10W**
 Light Color : Warm white
 Voltage : 220Vac
 IP Rating : IP54
 Unit price : 1860 THB



LS-6007

LED Bollard

Size : Dia.107 x H600mm.
 Aluminum die-cast
 Black powder coated
 Lamp : **LED COB 10W**
 Light Color : Warm white
 Voltage : 220Vac
 IP Rating : IP54
 Unit price : 2580 THB



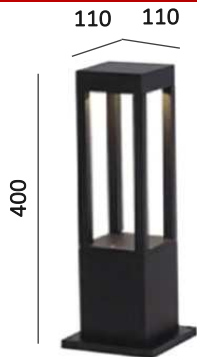

LS-4008

LED Bollard

Size : W110 x L110 x H400mm.

Aluminum die-cast

Black powder coated

Lamp : **LED COB 10W**

Light Color : Warm white

Voltage : 220Vac

IP Rating : IP54

Unit price : 2150 THB

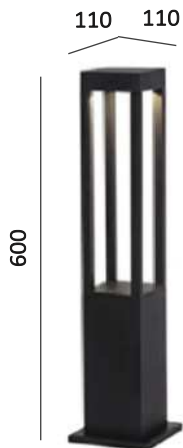

LS-6008

LED Bollard

Size : W110 x L110 x H600mm.

Aluminum die-cast

Black powder coated

Lamp : **LED COB 10W**

Light Color : Warm white

Voltage : 220Vac

IP Rating : IP54

Unit price : 2860 THB



LED DRIVER



2-4DC 600WMA 1x3W

Input : AC85-265V 50/60Hz

Output : DC2-4V

600mA

Dimension : W22 x L31 x H18mm.

IP20

Unit price : 100 THB

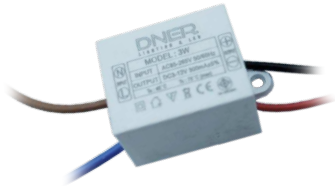

Dner Model 3W (Mini)

Input : AC85-265V 50/60Hz

Output : DC3-12V 300mA

Dimension : W22 x L28 x H20mm.

IP20

Unit price : 75 THB



Dner Model 3W (Large)

Input : AC85-265V 50/60Hz

Output : DC3-12V 300mA

Dimension : W27 x L40 x H20mm.

IP20

Unit price : 90 THB



DONE Model DL-3W300-L

Input : 100-277V 50/60Hz

Output : 6-11V 0.3A 3.3W

Dimension : W30 x L53 x H20mm.

IP20

Unit price : 100 THB



DONE DL-7W300-L

Input : 100-277V – 0.2A 50/60Hz

Output : 12-24V

0.3A P rated:7.2W

No load:DC 30V

Dimension : W29 x L65 x H20mm.

IP20

Unit price : 188 THB



LED Driver 7W 4-7W

Model LED0407-260-A0

Input : AC85-265V 50/60Hz

Output : DC12-26V Max30V

Constant current : 260 mA

Dimension : W33 x L69 x H21mm.

IP20

Unit price : 115 THB

LED DRIVER



24-42VDC LED Dimming

Model : 8-12W
Input : AC220V 50/60Hz
Output : DC24-42V
Constant current : 260 mA
Dimension : W32 x L68 x H22mm.
IP20
Unit price : 200 THB



LED Driver Model 30-36W

Input : AC85-265V 50/60Hz
Output : DC24-42V
Constant current : 750 mA
Dimension : W37 x L97 x H27mm.
IP20
Unit price : 330 THB



LED Driver 20W

Input : AC85-265V 50/60Hz
Output : DC24-38V
Dimension : W35 x L85 x H21mm.
600mA
Unit price : 215 THB



Dner LED Driver 9W

Input : AC160-265V 50/60Hz
Output : DC24-36V
Dimension : W x L x Hmm.
300mA
Unit price : 90 THB



DLY-B40V900-DNB

Input : 86-265VAC 50/60Hz
Output : 24-40VDC 900mA
Constant current
Dimension : W40 x L105 x 24mm.
IP20
Unit price : 315 THB



LED Driver for AR111

Model : 8-12W
Input : AC85-265V 50/60Hz
Output : DC24-42V
Dimension : W30 x L65 x H20mm.
260mA
Unit price : 200 THB

LED DRIVER



Driver Panel

Model : 12-18x1W
Input : AC85-265V 50/60Hz
Output : DC36-60V
Constant current : 260 mA
Dimension : W35 x L85 x H25mm.
IP20
Unit price : 230 THB



LED Driver 1-3x1W

Input : AC85-265V 50/60Hz
Output : DC3-12V
Constant current : 260 mA
Dimension : W25 x L35 x H20mm.
IP65
Unit price : 145 THB



LED Driver : HXS-4-7W

Input : AC90-255V 50/60Hz
Output : DC12-25V
Constant current : 250 mA
Dimension : W25 x L35 x H20mm.
IP65
Unit price : 200 THB



LED Driver : LW-299D

Input : AC220V 50/60Hz
Output : AC12V 50W
Dimension : W34 x L60 x H20mm.
IP20
Unit price : 230 THB



Halogen MR16 Driver LVED VAL 20/220-240/12

Input : AC220V 50/60Hz
Output : AC12V 2-20W
Dimension : W38 x L71.5 x H25mm.
IP20
Unit price : 290 THB





DONE DLC-3W300 M

Input : 100-240V 50/60Hz
Output : 6-11V
0.3A
3.3W
Dimension : W30 x L50 x H20mm.
IP67
Unit price : 200 THB



DONE DL-12W300-M

Input : 100-277V 50/60Hz
Output : 21-42V
0.3A 12.6W
Dimension : W30 x L63 x H21mm.
IP67
Unit price : 430 THB



DONE DL-7W-C300-MPC

Input : 100-277V 50/60Hz
Output : 12-24V
0.3A 7.2W
Dimension : W33 x L60 x H23mm.
IP67
Unit price : 250 THB



DONE DLC-50W1A5

Input : 100-277V 50/60Hz
Output : 18-36V
1.5A 54.0W
Dimension : W40 x L92 x H30mm.
IP67
Unit price : 860 THB



Water proof Power supply LED Driver 12V10W

Input : AC90-250V 50/60Hz
Output : DC12V
DC0.83A
Dimension : W30 x L97 x H20mm.
IP65
Unit price : 430 THB



Water proof Power supply

Model : KKF-36W-12V
Input : AC110-240V 50/60Hz
Output : DC12V 3A 36W
Dimension : W30 x L160 x H20mm.
IP67
Unit price : 715 THB



Water proof Power supply LED Driver 12V15W

Input : AC90-250V 50/60Hz
Output : DC12V
DC 1.25A
Dimension : W30 x L97 x H20mm.
IP65
Unit price : 500 THB



Water proof Power supply

Model : 12V60W
Input : AC110-240V 50/60Hz
Output : DC12V 5A 60W
Dimension : W46 x L163 x H34mm.
260mA
IP67
Unit price : 1150 THB



Water proof Power supply

Input : AC110-240V 50/60Hz
Output : DC24V
2.5A 60W
Dimension : W44 x L155 x H21mm.
IP65
Unit price : 1000 THB

12v



KKFP-12W-12
 Input : 220V
Output : DC12V 1A 12W
 Dimension : W40 x L70 x H32mm.
 IP20
Unit price : 215 THB

12v



KKCK-240W-12
 Input : 220V
Output : DC12V 20A 240W
 Dimension : W67 x L220 x H40mm.
 IP20
Unit price : 860 THB

12v



KKCK-60W-12
 Input : 220V
Output : DC12V 5A 60W
 Dimension : W40 x L160 x H32mm.
 IP20
Unit price : 430 THB

12v



KKCK-360W-12
 Input : 220V
Output : DC12V 30A 360W
 Dimension : W67 x L222 x H40mm.
 IP20
Unit price : 1000 THB

12v



KKCK-120W-12
 Input : 220V
Output : DC12V 10A 120W
 Dimension : W46 x L188 x H35mm.
 IP20
Unit price : 580 THB

12v



KKCK-180W-12
 Input : 220V
Output : DC12V 15A 180W
 Dimension : W58 x L200 x H40mm.
 IP20
Unit price : 715 THB

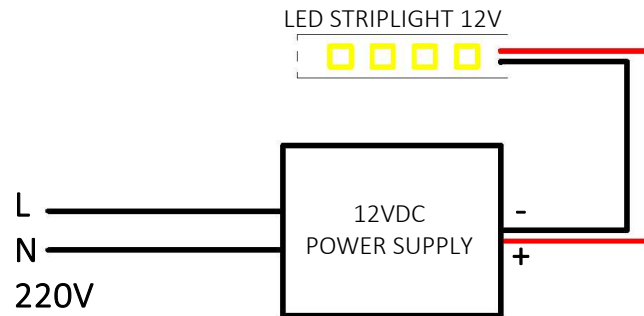

12v

**KKFP-36W-12**

Input : 220V
Output : DC12V 3A 36W
 Dimension : W58 x L85 H33mm.
 IP20
Unit price : 290 THB

12v

**KKFP-240W-12**

Input : 220V
Output : DC12V 20A 240W
 Dimension : W108 x L198 x H50mm.
 IP20
Unit price : 1100 THB

12v

**KKFP-60W-12**

Input : 220V
Output : DC12V 5A 60W
 Dimension : W78 x L110 x H36mm.
 IP20
Unit price : 380 THB

12v

**KKFP-360W-12**

Input : 220V
Output : DC12V 30A 360W
 Dimension : W114 x L214 x H50mm.
 IP20
Unit price : 1320 THB

12v

**KKFP-120W-12**

Input : 220V
Output : DC12V 10A 120W
 Dimension : W98 x L160 x H42mm.
 IP20
Unit price : 500 THB

12v

**KKFL-720W-12**

Input : 220V
Output : DC12V 60A 720W
 Dimension : W130 x L242 x H70mm.
 IP20
Unit price : 3400 THB

12v

**KKFP-180W-12**

Input : 220V
Output : DC12V 15A 180W
 Dimension : W108 x L198 x H42mm.
 IP20
Unit price : 630 THB

24v



KKCK-72W-24

Input : 220V
Output : DC24V 3A 72W
 Dimension : W40 x L160 x H32mm.
 IP20
 Unit price : 420 THB

24v



KKFL-480W-24

Input : 220V
Output : DC24V 20A 480W
 Dimension : W130 x L215 x H50mm.
 IP20
 Unit price : 1350 THB

24v



KKCK-120W-24

Input : 220V
Output : DC24V 5A 120W
 Dimension : W46 x L188 x H46mm.
 IP20
 Unit price : 520 THB

24v



KKFL-720W-24

Input : 220V
Output : DC24V 30A 720W
 Dimension : W130 x L242 x H70mm.
 IP20
 Unit price : 3860 THB

24v



KKCK-240W-24

Input : 220V
Output : DC24V 10A 240W
 Dimension : W67 x L222 x H40mm.
 IP20
 Unit price : 860 THB

24v



KKFL-360W-24

Input : 220V
Output : DC24V 15A 360W
 Dimension : W114 x L215 x H50mm.
 IP20
 Unit price : 1120 THB

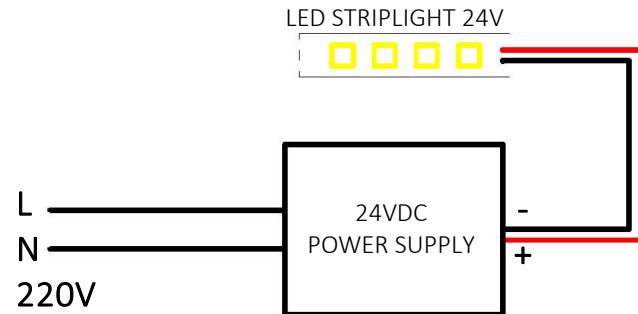

**New
Model**

12v



DNX-45W-12

Input : 220V

Output : DC12V 3.75A 45W

Dimension : W40 x L100 x H24mm.

IP20

Unit price : 375 THB

24v



DNX-45W-24

Input : 220V

Output : DC24V 1.8A 45W

Dimension : W40 x L100 x H24mm.

IP20

Unit price : 375 THB

12v



DNX-60W-12

Input : 220V

Output : DC12V 5A 60W

Dimension : W40 x L121 x H24mm.

IP20

Unit price : 520 THB

24v



DNX-60W-24

Input : 220V

Output : DC24V 2.5A 60W

Dimension : W40 x L121 x H24mm.

IP20

Unit price : 520 THB

12v



DNX-100W-12

Input : 220V

Output : DC12V 8A 100W

Dimension : W50 x L146 x H25mm.

IP20

Unit price : 620 THB

24v



DNX-100W-24

Input : 220V

Output : DC24V 4A 100W

Dimension : W50 x L146 x H25mm.

IP20

Unit price : 620 THB

12v



DNX-150W-12

Input : 220V

Output : DC12V 12.5A 150W

Dimension : W50 x L165 x H32mm.

IP20

Unit price : 720 THB

24v



DNX-150W-24

Input : 220V

Output : DC24V 6A 150W

Dimension : W50 x L165 x H32mm.

IP20

Unit price : 720 THB

**New
Model**

12v



DNX-200W-12

Input : 220V

Output : DC12V 16.7A 200W

Dimension : W58.5 x L189.5 x H28mm.

IP20

Unit price : 860 THB

24v



DNX-200W-24

Input : 220V

Output : DC24V 8.3A 200W

Dimension : W58.5 x L189.5 x H28mm.

IP20

Unit price : 860 THB

12v



DNX-300W-12

Input : 220V

Output : DC12V 25A 300W

Dimension : W58.5 x L222.5 x H28mm.

IP20

Unit price : 1,000 THB

24v



DNX-300W-24

Input : 220V

Output : DC24V 12.5A 300W

Dimension : W58.5 x L222.5 x H28mm.

IP20

Unit price : 1,000 THB

12v



DNX-400W-12

Input : 220V

Output : DC12V 33A 400W

Dimension : W62 x L228 x H28mm.

IP20

Unit price : 1,145 THB

24v



DNX-400W-24

Input : 220V

Output : DC24V 16.6A 400W

Dimension : W62 x L228 x H28mm.

IP20

Unit price : 1,145 THB

12v



DNGP100W12V

Input : 220V
Output : DC12V 8.3A 100W
Dimension : W58 x L165 x H29mm.
IP20
Unit price : 1,430 THB

24v



DNGP100W24V

Input : 220V
Output : DC24V 4.1A 100W
Dimension : W58 x L165 x H29mm.
IP20
Unit price : 1,430 THB

12v



DNGP200W12V

Input : 220V
Output : DC12V 16.7A 200W
Dimension : W59 x L190 x H29mm.
IP20
Unit price : 1,930 THB

24v



DNGP200W24V

Input : 220V
Output : DC24V 8.3 A 200W
Dimension : W59 x L190 x H29mm.
IP20
Unit price : 1,930 THB

12v



DNGP300W12V

Input : 220V
Output : DC12V 25A 300W
Dimension : W63 x L224 x H30mm.
IP20
Unit price : 2,286 THB

24v



DNGP300W24V

Input : 220V
Output : DC24V 12.5A 300W
Dimension : W63 x L224 x H30mm.
IP20
Unit price : 2,286 THB

12v



DNGP400W12V

Input : 220V
Output : DC12V 33A 400W
Dimension : W63 x L239 x H30mm.
IP20
Unit price : 2,572 THB

24v



DNGP400W24V

Input : 220V
Output : DC24V 16.6A 400W
Dimension : W63 x L239 x H30mm.
IP20
Unit price : 2,572 THB



12v

**LRS-15-12**

Input : 220V

Output : **DC12V /15W /1.25A**

Dimension : W51 x L62.5 x H28mm.

IP20

Unit price : 700 THB



12v

**LRS-50-12**

Input : 220V

Output : **DC12V /50W /4.2A**

Dimension : W82 x L99 x H30mm.

IP20

Unit price : 1000 THB



12v

**LRS-25-12**

Input : 220V

Output : **DC12V /25W /1.25A**

Dimension : W51 x L78 x H28mm.

IP20

Unit price : 845 THB



12v

**LRS-75-12**

Input : 220V

Output : **DC12V /75W /6.3A**

Dimension : W97 x L99 x H30mm.

IP20

Unit price : 1275 THB



12v

**LRS-35-12**

Input : 220V

Output : **DC12V /35W /2.9A**

Dimension : W82 x L99 x H30mm.

IP20

Unit price : 1000 THB



12v

**LRS-100-12**

Input : 220V

Output : DC12V /100W / 8.3A

Dimension : W97 x L129 x H30mm.

IP20

Unit price : 1360 THB



12v

**LRS-350-12**

Input : 220V

Output : DC12V /350W / 29.2A

Dimension : W115 x L215 x H30mm.

IP20

Unit price : 2790 THB



12v

**LRS-150-12**

Input : 220V

Output : DC12V /150W / 12.5A

Dimension : W97 x L159 x H30mm.

IP20

Unit price : 1690 THB



12v

**LRS-450-12**

Input : 220V

Output : DC12V /450W / 37.5A

Dimension : W124 x L215 x H35mm.

IP20

Unit price : 4790 THB



12v

**LRS-200-12**

Input : 220V

Output : DC12V /200W / 16.7A

Dimension : W115 x L215 x H30mm.

IP20

Unit price : 2250 THB



12v

**LRS-600-12**

Input : 220V

Output : DC12V /600W / 50A

Dimension : W124 x L225 x H41mm.

IP20

Unit price : 5360 THB



24v

**LRS-35-24**

Input : 220V

Output : DC24V /35W /1.46A

Dimension : W82 x L99 x H30mm.

IP20

Unit price : 1000 THB

24v

**LRS-50-24**

Input : 220V

Output : DC24V /50W /2.2A

Dimension : W82 x L99 x H30mm.

IP20

Unit price : 1050 THB

24v

**LRS-75-24**

Input : 220V

Output : DC24V /75W /3.2A

Dimension : W97 x L99 x H30mm.

IP20

Unit price : 1150 THB

24v

**LRS-100-24**

Input : 220V

Output : DC24V /108W /4.5A

Dimension : W97 x L129 x H30mm.

IP20

Unit price : 1400 THB

24v

**LRS-150-24**

Input : 220V

Output : DC24V /156W /6.5A

Dimension : W97 x L159 x H30mm.

IP20

Unit price : 1700 THB

24v

**LRS-200-24**

Input : 220V

Output : DC24V /211W /8.8A

Dimension : W115 x L215 x H30mm.

IP20

Unit price : 2290 THB

24v

**LRS-350-24**

Input : 220V

Output : DC24V /350W /14.6A

Dimension : W115 x L215 x H30mm.

IP20

Unit price : 2690 THB



24v

**LRS-450-24**

Input : 220V

Output : DC24V /450W / 18.75A

Dimension : W124 x L225 x H35mm.

IP20

Unit price : 4790 THB



24v

**LRS-600-24**

Input : 220V

Output : DC24V /600W / 25A

Dimension : W124 x L225 x H41mm.

IP20

Unit price : 5380 THB



12v

**LPV-60-12**

Input : 220V

Output : DC12V /60W /5A

Dimension : W45.2 x L162.5 x H32mm.

IP67

Unit price : 1720 THB



24v

**LPV-60-24**

Input : 220V

Output : DC24V /60W /2.5A

Dimension : W45.2 x L162.5 x H32mm.

IP67

Unit price : 1720 THB



12v

**LPV-100-12**

Input : 220V

Output : DC12V /100W /8.5A

Dimension : W52 x L190 x H37mm.

IP67

Unit price : 2930 THB



24v

**LPV-100-24**

Input : 220V

Output : DC24V /100W /4.2A

Dimension : W52 x L191 x H37.5mm.

IP67

Unit price : 2930 THB



12v

**LPV-150-12**

Input : 220V

Output : DC12V /150W /10A

Dimension : W63 x L191 x H37.5mm.

IP67

Unit price : 4000 THB



24v

**LPV-150-24**

Input : 220V

Output : DC24V /150W /6.25A

Dimension : W63 x L191 x H37.5mm.

IP67

Unit price : 4000 THB



12v

**RSP-75-12**

Input : 220V

Output : DC12V /75W

Dimension : W97 x L159 x H30mm.

IP20

Unit price : 3715 THB



12v

**RSP-200-12**

Input : 220V

Output : DC12V /200W

Dimension : W115 x L215 x H30mm.

IP20

Unit price : 4690 THB



12v

**RSP-100-12**

Input : 220V

Output : DC12V /100W

Dimension : W99 x L179 x H30mm.

IP20

Unit price : 4090 THB



12v

**RSP-320-12**

Input : 220V

Output : DC12V /320W

Dimension : W115 x L215 x H30mm.

IP20

Unit price : 5430 THB



12v

**RSP-150-12**

Input : 220V

Output : DC12V /150W

Dimension : W99 x L199 x H30mm.

IP20

Unit price : 4290 THB



12v

**RSP-500-12**

Input : 220V

Output : DC12V /500W

Dimension : W127 x L230 x H40.5mm.

IP20

Unit price : 8790 THB



24v

**RSP-75-24**

Input : 220V

Output : DC24V /75W

Dimension : W97 x L159 x H30mm.

IP20

Unit price : 3715 THB



24v

**RSP-200-24**

Input : 220V

Output : DC24V /200W

Dimension : W115 x L215 x H30mm.

IP20

Unit price : 4690 THB



24v

**RSP-100-24**

Input : 220V

Output : DC24V /100W

Dimension : W99 x L179 x H30mm.

IP20

Unit price : 4090 THB



24v

**RSP-320-24**

Input : 220V

Output : DC24V /320W

Dimension : W115 x L215 x H30mm.

IP20

Unit price : 5430 THB



24v

**RSP-150-24**

Input : 220V

Output : DC24V /150W

Dimension : W99 x L199 x H30mm.

IP20

Unit price : 4290 THB



24v

**RSP-500-24**

Input : 220V

Output : DC24V /500W

Dimension : W127 x L230 x H40.5mm.

IP20

Unit price : 8790 THB

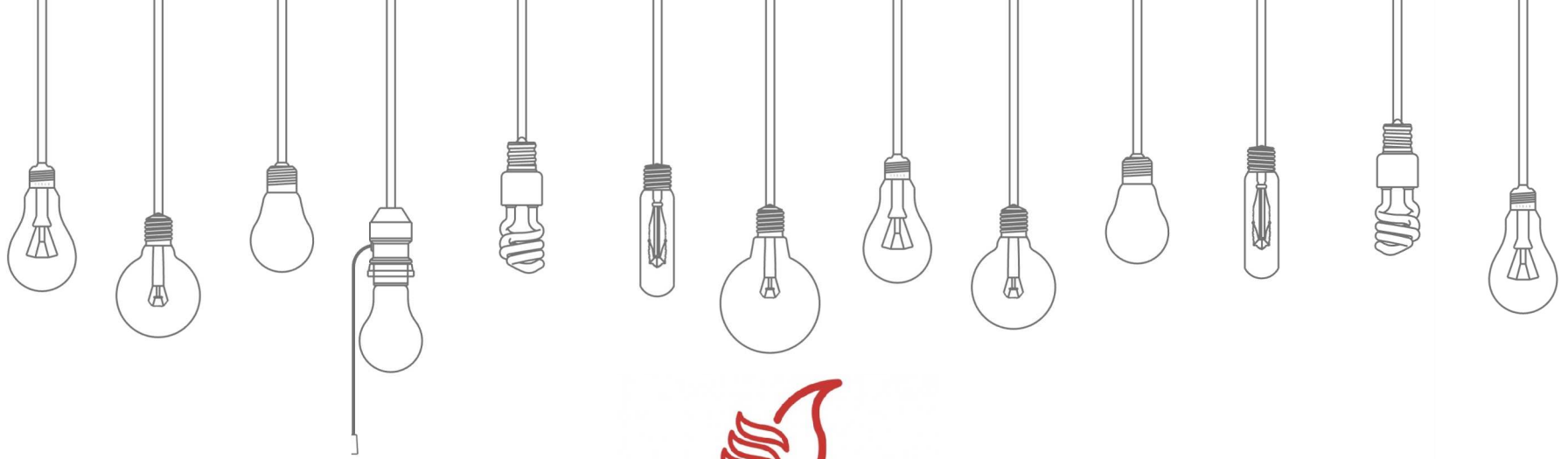

DNER
LIGHTING & LED

THANK YOU